

EcoStruxure Machine Expert - Basic Operating Guide

12/2018

EIO0000003281.00

www.schneider-electric.com



The information provided in this documentation contains general descriptions and/or technical characteristics of the performance of the products contained herein. This documentation is not intended as a substitute for and is not to be used for determining suitability or reliability of these products for specific user applications. It is the duty of any such user or integrator to perform the appropriate and complete risk analysis, evaluation and testing of the products with respect to the relevant specific application or use thereof. Neither Schneider Electric nor any of its affiliates or subsidiaries shall be responsible or liable for misuse of the information contained herein. If you have any suggestions for improvements or amendments or have found errors in this publication, please notify us.

You agree not to reproduce, other than for your own personal, noncommercial use, all or part of this document on any medium whatsoever without permission of Schneider Electric, given in writing. You also agree not to establish any hypertext links to this document or its content. Schneider Electric does not grant any right or license for the personal and noncommercial use of the document or its content, except for a non-exclusive license to consult it on an "as is" basis, at your own risk. All other rights are reserved.

All pertinent state, regional, and local safety regulations must be observed when installing and using this product. For reasons of safety and to help ensure compliance with documented system data, only the manufacturer should perform repairs to components.

When devices are used for applications with technical safety requirements, the relevant instructions must be followed.

Failure to use Schneider Electric software or approved software with our hardware products may result in injury, harm, or improper operating results.

Failure to observe this information can result in injury or equipment damage.

© 2018 Schneider Electric. All rights reserved.

Table of Contents



	Safety Information	9
	About the Book	11
Part I	Getting Started with EcoStruxure Machine Expert - Basic	19
Chapter 1	Introduction to EcoStruxure Machine Expert - Basic . . .	21
1.1	System Requirements and Supported Devices	22
	System Requirements	23
	Supported Devices	24
	Supported Programming Languages	26
1.2	EcoStruxure Machine Expert - Basic User Interface Basics	27
	Creating Projects With EcoStruxure Machine Expert - Basic	28
	Developing Programs With EcoStruxure Machine Expert - Basic . . .	29
	Navigating Within EcoStruxure Machine Expert - Basic	30
	Operating Modes	31
1.3	The Start Menu	32
	Introduction to the Start Menu	33
	Registering the EcoStruxure Machine Expert - Basic Software	34
	Open Project Window	35
	Project Templates Window	38
	Help Window	39
Part II	Developing EcoStruxure Machine Expert - Basic Applications	41
Chapter 2	The EcoStruxure Machine Expert - Basic Window	43
2.1	Overview of the EcoStruxure Machine Expert - Basic Window	44
	Toolbar Buttons	45
	Status Area	47
	System Settings	49
	Print Reports	51
Chapter 3	Properties	53
3.1	Overview of the Properties Window	54
	The Properties Window	55
	Project Properties	56

Chapter 4 Configuration	59
4.1 Overview of the Configuration Window	60
Overview of the Configuration Window	61
Building a Configuration	62
Chapter 5 Programming	63
5.1 Overview of the Programming Workspace	64
Overview of the Programming Workspace	64
5.2 Special Functions	66
Objects	67
Symbolic Addressing	68
Memory Allocation	70
Ladder/List Reversibility	71
5.3 Configuring Program Behavior and Tasks	76
Application Behavior	77
Tasks and Scan Modes	82
5.4 Managing POUs	85
POUs	86
Managing POUs with Tasks	87
Managing Rungs	90
Managing Grafcet (SFC) POUs	93
Free POUs	95
5.5 User-Defined Functions	99
Creating a User-Defined Function	100
Defining a User-Defined Function	101
Managing User-Defined Functions	105
5.6 User-Defined Function Blocks	107
Creating a User-Defined Function Block	108
Defining a User-Defined Function Block	109
Managing User-Defined Function Blocks	113
5.7 Master Task	115
Master Task Description	116
Configuring Master Task	117
5.8 Strings	119
Configuring Strings in Constant words	120
Assigning Strings in Memory Words	121
Managing Strings	122

5.9	Periodic Task	125
	Creating Periodic Task	126
	Configuring Periodic Task Scan Duration	128
5.10	Event Task	129
	Overview of Event Tasks	130
	Event Sources	131
	Event Priorities	132
	Viewing Event Tasks	133
5.11	Using Tools	136
	Messages	137
	Animation Tables	139
	Memory Objects	145
	System Objects	150
	I/O Objects	151
	Network Objects	152
	Software Objects	153
	PTO Objects	154
	Drive Objects	155
	Communication Objects	156
	Search and Replace	157
	Cross Reference	159
	Symbol List	160
	Memory Consumption View	165
5.12	Ladder Language Programming	167
	Introduction to Ladder Diagrams	168
	Programming Principles for Ladder Diagrams	170
	Color Coding of Rungs	172
	Ladder Diagram Graphic Elements	174
	Comparison Blocks	181
	Operation Blocks	182
	Adding Comments	186
	Programming Best Practices	187
5.13	Instruction List Programming	190
	Overview of Instruction List Programs	191
	Operation of List Instructions	194
	List Language Instructions	195
	Using Parentheses	199

5.14	Grafcet (List) Programming	202
	Description of Grafcet (List) Programming	203
	Grafcet (List) Program Structure	204
	How to Use Grafcet (List) Instructions in an EcoStruxure Machine Expert - Basic Program	208
5.15	Grafcet (SFC) Programming	210
	Introduction to Grafcet (SFC) Programming	211
	Using the Grafcet (SFC) Graphical Editor	214
	Branching	219
	Programming Best Practices	223
5.16	Debugging in Online Mode.	225
	Trace Window	226
	Modifying Values	229
	Forcing Values	230
	Online Mode Modifications.	231
Chapter 6	Commissioning.	239
6.1	Overview of the Commissioning Window.	240
	Overview of the Commissioning Window.	240
6.2	Connect to a Logic Controller	241
	Connecting to a Logic Controller	242
	Downloading and Uploading Applications	249
6.3	Controller Update	253
	Controller Firmware Updates	253
6.4	Memory Management	254
	Managing Logic Controller Memory	254
6.5	Controller Info	260
	Controller Information.	260
6.6	RTC Management	262
	Managing the RTC.	262
Chapter 7	Simulator	263
	Overview of the EcoStruxure Machine Expert - Basic Simulator	264
	EcoStruxure Machine Expert - Basic Simulator I/O Manager Window	266
	EcoStruxure Machine Expert - Basic Simulator Time Management Window	268
	Modifying Values Using EcoStruxure Machine Expert - Basic Simulator	271
	How to Use the EcoStruxure Machine Expert - Basic Simulator	275
	Launching Simulation in Vijeo-Designer	276

Chapter 8	Saving Projects and Closing EcoStruxure Machine Expert	
	- Basic	277
	Saving a Project	278
	Saving a Project As a Template	279
	Closing EcoStruxure Machine Expert - Basic	280
Appendices	281
Appendix A	Converting Twido Projects to EcoStruxure Machine	
	Expert - Basic	283
	Converting Twido Projects to EcoStruxure Machine Expert - Basic . .	283
Appendix B	EcoStruxure Machine Expert - Basic Keyboard Shortcuts	293
	EcoStruxure Machine Expert - Basic Keyboard Shortcuts	293
Glossary	299
Index	303

Safety Information



Important Information

NOTICE

Read these instructions carefully, and look at the equipment to become familiar with the device before trying to install, operate, service, or maintain it. The following special messages may appear throughout this documentation or on the equipment to warn of potential hazards or to call attention to information that clarifies or simplifies a procedure.



The addition of this symbol to a “Danger” or “Warning” safety label indicates that an electrical hazard exists which will result in personal injury if the instructions are not followed.



This is the safety alert symbol. It is used to alert you to potential personal injury hazards. Obey all safety messages that follow this symbol to avoid possible injury or death.

DANGER

DANGER indicates a hazardous situation which, if not avoided, **will result in** death or serious injury.

WARNING

WARNING indicates a hazardous situation which, if not avoided, **could result in** death or serious injury.

CAUTION

CAUTION indicates a hazardous situation which, if not avoided, **could result** in minor or moderate injury.

NOTICE

NOTICE is used to address practices not related to physical injury.

PLEASE NOTE

Electrical equipment should be installed, operated, serviced, and maintained only by qualified personnel. No responsibility is assumed by Schneider Electric for any consequences arising out of the use of this material.

A qualified person is one who has skills and knowledge related to the construction and operation of electrical equipment and its installation, and has received safety training to recognize and avoid the hazards involved.

About the Book



At a Glance

Document Scope

This guide describes how to use the EcoStruxure Machine Expert - Basic software to configure, program, and commission applications for supported logic controllers.

Validity Note

The information in this manual is applicable **only** for EcoStruxure Machine Expert - Basic products.

This document has been updated for the release of EcoStruxure™ Machine Expert - Basic V1.0.

The technical characteristics of the devices described in the present document also appear online. To access the information online:

Step	Action
1	Go to the Schneider Electric home page www.schneider-electric.com .
2	In the Search box type the reference of a product or the name of a product range. <ul style="list-style-type: none">• Do not include blank spaces in the reference or product range.• To get information on grouping similar modules, use asterisks (*).
3	If you entered a reference, go to the Product Datasheets search results and click on the reference that interests you. If you entered the name of a product range, go to the Product Ranges search results and click on the product range that interests you.
4	If more than one reference appears in the Products search results, click on the reference that interests you.
5	Depending on the size of your screen, you may need to scroll down to see the data sheet.
6	To save or print a data sheet as a .pdf file, click Download XXX product datasheet .

The characteristics that are presented in the present document should be the same as those characteristics that appear online. In line with our policy of constant improvement, we may revise content over time to improve clarity and accuracy. If you see a difference between the document and online information, use the online information as your reference.

Related Documents

Title of Documentation	Reference Number
EcoStruxure Machine Expert - Basic Generic Functions - Library Guide	EIO0000003289 (ENG) EIO0000003290 (FRE) EIO0000003291 (GER) EIO0000003292 (SPA) EIO0000003293 (ITA) EIO0000003294 (CHS) EIO0000003295 (POR) EIO0000003296 (TUR)
Modicon M221 Logic Controller Advanced Functions - Library Guide	EIO0000003305 (ENG) EIO0000003306 (FRE) EIO0000003307 (GER) EIO0000003308 (SPA) EIO0000003309 (ITA) EIO0000003310 (CHS) EIO0000003311 (POR) EIO0000003312 (TUR)
Modicon M221 Logic Controller - Programming Guide	EIO0000003297 (ENG) EIO0000003298 (FRE) EIO0000003299 (GER) EIO0000003300 (SPA) EIO0000003301 (ITA) EIO0000003302 (CHS) EIO0000003303 (POR) EIO0000003304 (TUR)
Modicon M221 Logic Controller - Hardware Guide	EIO0000003313 (ENG) EIO0000003314 (FRE) EIO0000003315 (GER) EIO0000003316 (SPA) EIO0000003317 (ITA) EIO0000003318 (CHS) EIO0000003319 (POR) EIO0000003320 (TUR)
Modicon TMC2 Cartridge - Programming Guide	EIO0000003329 (ENG) EIO0000003330 (FRE) EIO0000003331 (GER) EIO0000003332 (SPA) EIO0000003333 (ITA) EIO0000003334 (CHS) EIO0000003335 (POR) EIO0000003336 (TUR)

Title of Documentation	Reference Number
Modicon TMC2 Cartridge - Hardware Guide	EIO0000003337 (ENG) EIO0000003338 (FRE) EIO0000003339 (GER) EIO0000003340 (SPA) EIO0000003341 (ITA) EIO0000003342 (CHS) EIO0000003343 (POR) EIO0000003344 (TUR)
Modicon TM3 Expansion Modules Configuration - Programming Guide	EIO0000003345 (ENG) EIO0000003346 (FRE) EIO0000003347 (GER) EIO0000003348 (SPA) EIO0000003349 (ITA) EIO0000003350 (CHS) EIO0000003351 (POR) EIO0000003352 (TUR)
Modicon TM3 Digital I/O Modules - Hardware Guide	EIO0000003125 (ENG) EIO0000003126 (FRE) EIO0000003127 (GER) EIO0000003128 (SPA) EIO0000003129 (ITA) EIO0000003130 (CHS) EIO0000003424 (POR) EIO0000003425 (TUR)
Modicon TM3 Analog I/O Modules - Hardware Guide	EIO0000003131 (ENG) EIO0000003132 (FRE) EIO0000003133 (GER) EIO0000003134 (SPA) EIO0000003135 (ITA) EIO0000003136 (CHS) EIO0000003426 (POR) EIO0000003427 (TUR)
Modicon TM3 Expert Modules - Hardware Guide	EIO0000003137 (ENG) EIO0000003138 (FRE) EIO0000003139 (GER) EIO0000003140 (SPA) EIO0000003141 (ITA) EIO0000003142 (CHS) EIO0000003428 (POR) EIO0000003429 (TUR)

Title of Documentation	Reference Number
Modicon TM3 Safety Modules - Hardware Guide	EIO0000003353 (ENG) EIO0000003354 (FRE) EIO0000003355 (GER) EIO0000003356 (SPA) EIO0000003357 (ITA) EIO0000003358 (CHS) EIO0000003359 (POR) EIO0000003360 (TUR)
Modicon TM3 Transmitter and Receiver Modules - Hardware Guide	EIO0000003143 (ENG) EIO0000003144 (FRE) EIO0000003145 (GER) EIO0000003146 (SPA) EIO0000003147 (ITA) EIO0000003148 (CHS) EIO0000003430 (POR) EIO0000003431 (TUR)
Modicon TM2 Expansion Modules Configuration - Programming Guide	EIO0000003432 (ENG) EIO0000003433 (FRE) EIO0000003434 (GER) EIO0000003435 (SPA) EIO0000003436 (ITA) EIO0000003437 (CHS)
Modicon TM2 Digital I/O Modules - Hardware Guide	EIO0000000028 (ENG) EIO0000000029 (FRE) EIO0000000030 (GER) EIO0000000031 (SPA) EIO0000000032 (ITA) EIO0000000033 (CHS)
Modicon TM2 Analog I/O Modules - Hardware Guide	EIO0000000034 (ENG) EIO0000000035 (FRE) EIO0000000036 (GER) EIO0000000037 (SPA) EIO0000000038 (ITA) EIO0000000039 (CHS)
SR2MOD02 and SR2MOD03 Wireless Modem - User Guide	EIO0000001575 (ENG)

You can download these technical publications and other technical information from our website at <https://www.schneider-electric.com/en/download>

Product Related Information

WARNING

LOSS OF CONTROL

- The designer of any control scheme must consider the potential failure modes of control paths and, for certain critical control functions, provide a means to achieve a safe state during and after a path failure. Examples of critical control functions are emergency stop and overtravel stop, power outage and restart.
- Separate or redundant control paths must be provided for critical control functions.
- System control paths may include communication links. Consideration must be given to the implications of unanticipated transmission delays or failures of the link.
- Observe all accident prevention regulations and local safety guidelines.¹
- Each implementation of this equipment must be individually and thoroughly tested for proper operation before being placed into service.

Failure to follow these instructions can result in death, serious injury, or equipment damage.

¹ For additional information, refer to NEMA ICS 1.1 (latest edition), "Safety Guidelines for the Application, Installation, and Maintenance of Solid State Control" and to NEMA ICS 7.1 (latest edition), "Safety Standards for Construction and Guide for Selection, Installation and Operation of Adjustable-Speed Drive Systems" or their equivalent governing your particular location.

WARNING

UNINTENDED EQUIPMENT OPERATION

- Only use software approved by Schneider Electric for use with this equipment.
- Update your application program every time you change the physical hardware configuration.

Failure to follow these instructions can result in death, serious injury, or equipment damage.

Terminology Derived from Standards

The technical terms, terminology, symbols and the corresponding descriptions in this manual, or that appear in or on the products themselves, are generally derived from the terms or definitions of international standards.

In the area of functional safety systems, drives and general automation, this may include, but is not limited to, terms such as *safety*, *safety function*, *safe state*, *fault*, *fault reset*, *malfunction*, *failure*, *error*, *error message*, *dangerous*, etc.

Among others, these standards include:

Standard	Description
IEC 61131-2:2007	Programmable controllers, part 2: Equipment requirements and tests.
ISO 13849-1:2015	Safety of machinery: Safety related parts of control systems. General principles for design.
EN 61496-1:2013	Safety of machinery: Electro-sensitive protective equipment. Part 1: General requirements and tests.
ISO 12100:2010	Safety of machinery - General principles for design - Risk assessment and risk reduction
EN 60204-1:2006	Safety of machinery - Electrical equipment of machines - Part 1: General requirements
ISO 14119:2013	Safety of machinery - Interlocking devices associated with guards - Principles for design and selection
ISO 13850:2015	Safety of machinery - Emergency stop - Principles for design
IEC 62061:2005	Safety of machinery - Functional safety of safety-related electrical, electronic, and electronic programmable control systems
IEC 61508-1:2010	Functional safety of electrical/electronic/programmable electronic safety-related systems: General requirements.
IEC 61508-2:2010	Functional safety of electrical/electronic/programmable electronic safety-related systems: Requirements for electrical/electronic/programmable electronic safety-related systems.
IEC 61508-3:2010	Functional safety of electrical/electronic/programmable electronic safety-related systems: Software requirements.
IEC 61784-3:2016	Industrial communication networks - Profiles - Part 3: Functional safety fieldbuses - General rules and profile definitions.
2006/42/EC	Machinery Directive
2014/30/EU	Electromagnetic Compatibility Directive
2014/35/EU	Low Voltage Directive

In addition, terms used in the present document may tangentially be used as they are derived from other standards such as:

Standard	Description
IEC 60034 series	Rotating electrical machines
IEC 61800 series	Adjustable speed electrical power drive systems
IEC 61158 series	Digital data communications for measurement and control – Fieldbus for use in industrial control systems

Finally, the term *zone of operation* may be used in conjunction with the description of specific hazards, and is defined as it is for a *hazard zone* or *danger zone* in the *Machinery Directive (2006/42/EC)* and *ISO 12100:2010*.

NOTE: The aforementioned standards may or may not apply to the specific products cited in the present documentation. For more information concerning the individual standards applicable to the products described herein, see the characteristics tables for those product references.

Part I

Getting Started with EcoStruxure Machine Expert - Basic

Chapter 1

Introduction to EcoStruxure Machine Expert - Basic

What Is in This Chapter?

This chapter contains the following sections:

Section	Topic	Page
1.1	System Requirements and Supported Devices	22
1.2	EcoStruxure Machine Expert - Basic User Interface Basics	27
1.3	The Start Menu	32

Section 1.1

System Requirements and Supported Devices

What Is in This Section?

This section contains the following topics:

Topic	Page
System Requirements	23
Supported Devices	24
Supported Programming Languages	26

System Requirements

Overview

The minimum system requirements for the PC on which EcoStruxure Machine Expert - Basic software is installed are:

- Intel Core 2 Duo processor or greater
- 1 GB RAM
- Display resolution 1280 x 768 pixels or greater
- The 32- or 64-bit version of one of the following operating systems:
 - Microsoft Windows 7
 - Microsoft Windows 8
 - Microsoft Windows 8.1
 - Microsoft Windows 10

Supported Devices

M221 Logic Controllers

For more information about the M221 logic controller configuration, refer to the following programming and hardware guides:

Logic Controller Type	Hardware Guide	Programming Guide
M221 Logic Controllers	Modicon M221 Logic Controller Hardware Guide	Modicon M221 Logic Controller Programming Guide

TM3 Expansion Modules

For more information about module configuration, refer to the following programming and hardware guides of each expansion module type:

Expansion Module Type	Hardware Guide	Programming Guide
TM3 Digital I/O Expansion Modules	TM3 Digital I/O Expansion Modules Hardware Guide	TM3 Expansion Modules Programming Guide
TM3 Analog I/O Expansion Modules	TM3 Analog Modules Hardware Guide	
TM3 Expert I/O Expansion Modules	TM3 Expert I/O Modules Hardware Guide	
TM3 Safety Modules	TM3 Safety Modules Hardware Guide	
TM3 Transmitter and Receiver Modules	TM3 Transmitter and Receiver Modules Hardware Guide	

TM2 Expansion Modules

For more information about module configuration, refer to the programming and hardware guides of each expansion module type:

Expansion Module Type	Hardware Guide	Programming Guide
TM2 Digital I/O Modules	TM2 Digital I/O Modules Hardware Guide	TM2 Expansion Modules Programming Guide
TM2 Analog I/O Modules	TM2 Analog I/O Modules Hardware Guide	

TMC2 Cartridges

For more information about cartridge configuration, refer to the following programming and hardware guides:

Cartridge Type	Hardware Guide	Programming Guide
TMC2 Cartridges	TMC2 Cartridges Hardware Guide	TMC2 Cartridges Programming Guide

TMH2GDB Remote Graphic Display

For information about the Remote Graphic Display installation, compatibility, configuration, and operation, refer to the following guide:

Display Type	User Guide
Remote Graphic Display	TMH2GDB Remote Graphic Display User Guide

Supported Programming Languages

Overview

A programmable logic controller reads inputs, writes outputs, and solves logic based on a control program. Creating a control program for a logic controller consists of writing a series of instructions in one of the supported programming languages.

EcoStruxure Machine Expert - Basic supports the following IEC-61131-3 programming languages:

- Ladder Diagram language
- Instruction List language
- Grafset (List)
- Grafset (SFC)

Section 1.2

EcoStruxure Machine Expert - Basic User Interface Basics

What Is in This Section?

This section contains the following topics:

Topic	Page
Creating Projects With EcoStruxure Machine Expert - Basic	28
Developing Programs With EcoStruxure Machine Expert - Basic	29
Navigating Within EcoStruxure Machine Expert - Basic	30
Operating Modes	31

Creating Projects With EcoStruxure Machine Expert - Basic

Overview

EcoStruxure Machine Expert - Basic is a graphical programming tool designed to make it easy to configure, develop, and commission programs for logic controllers.

Some Essential Terminology

EcoStruxure Machine Expert - Basic uses the following terms:

- **Project:** An EcoStruxure Machine Expert - Basic project contains details about the developer and purpose of the project, the configuration of the logic controller and associated expansion modules targeted by the project, the source code of a program, symbols, comments, documentation, and all other related information.
- **Application:** Contains all parts of the project that are downloaded to the logic controller, including the compiled program, hardware configuration information, and non-program data (project properties, symbols, and comments).
- **Program:** The compiled source code that runs on the logic controller.
- **POU** (program organization unit): The reusable object that contains a variable declaration and a set of instructions used in a program.

Developing Programs With EcoStruxure Machine Expert - Basic

Introduction

The following diagram shows the typical stages of developing a project in EcoStruxure Machine Expert - Basic (the **Configuration**, **Programming** and **Commissioning** tabs):

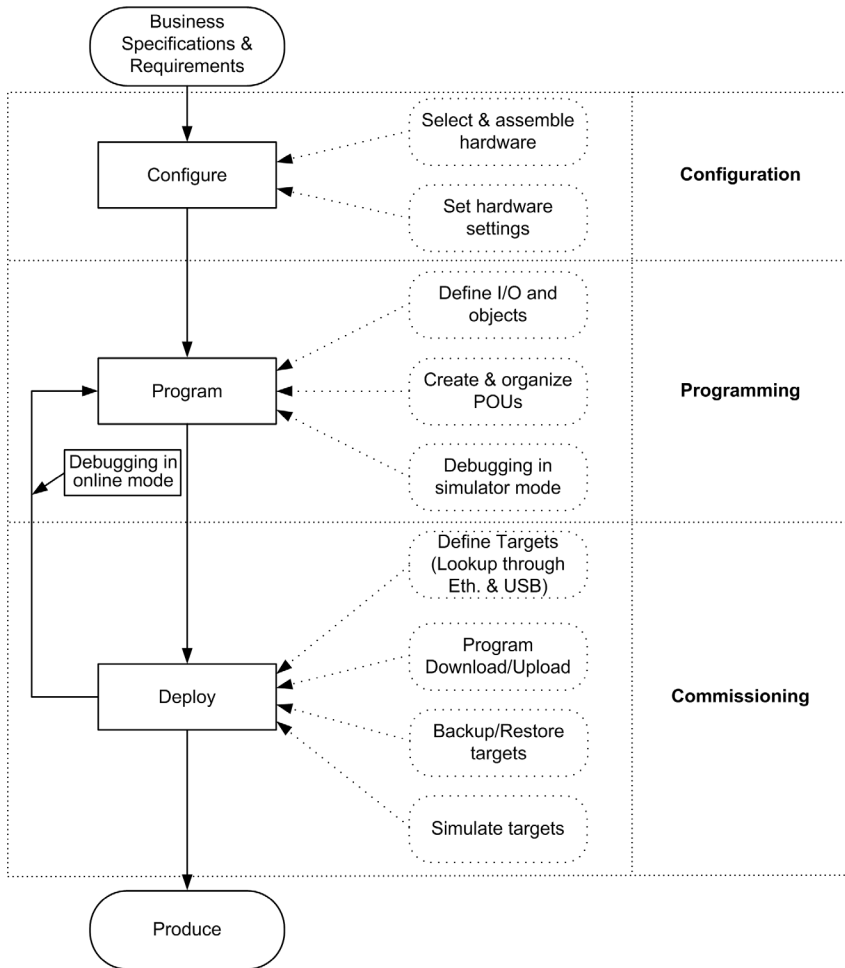

Navigating Within EcoStruxure Machine Expert - Basic

Module Areas

Once you have selected a project to work with, EcoStruxure Machine Expert - Basic displays the main window.

At the top of the main window, a toolbar (*see page 45*) contains icons that allow you to perform common tasks, including opening the **Start Menu**.

Next to the toolbar, the status bar (*see page 47*) displays informational messages about the current state of the connection to the logic controller.

Below this, the main window is divided into a number of *modules*. Each module controls a different stage of the development cycle, and is accessible by clicking a tab at the top of the module area. To develop an application, work your way through the modules from left to right:

- **Properties** (*see page 53*)
Set up the project properties
- **Configuration** (*see page 59*)
Define the hardware configuration of the logic controller and associated expansion modules
- **Programming** (*see page 63*)
Develop your program in one of the supported programming languages
- **Display** (*see Modicon M221, Logic Controller, Programming Guide*)
Build an operator interface for the TMH2GDB Remote Graphic Display module
- **Commissioning** (*see page 239*)
Manage the connection between EcoStruxure Machine Expert - Basic and the logic controller, upload/download applications, test, and commission the application.

Operating Modes

Introduction

The operating modes provide control to develop, debug, monitor, and modify the application when the controller is connected or not connected to EcoStruxure Machine Expert - Basic.

EcoStruxure Machine Expert - Basic can operate in the following modes:

- Offline mode
- Online mode
- Simulator mode

Offline Mode

EcoStruxure Machine Expert - Basic operates in offline mode when no physical connection to a logic controller has been established.

In offline mode, you configure EcoStruxure Machine Expert - Basic to match the hardware components you are targeting, then develop your application.

Online Mode

EcoStruxure Machine Expert - Basic operates in online mode when a logic controller is physically connected to the PC.

In online mode, you can proceed to download your application to the logic controller (downloading and uploading application is not possible in the simulator mode because the application is directly saved in the simulated logic controller). EcoStruxure Machine Expert - Basic then synchronizes the application in the PC memory with the version stored in the logic controller, allowing you to debug, monitor, and modify the application.

You can modify certain elements of a program in online mode. For example, you can add or delete rungs, or modify the values of certain function block parameters.

NOTE: Online program modifications are subjected to the predefined configuration. See Memory Management. Refer to Debugging in Online Mode ([see page 225](#)) for more information.

Simulator Mode

EcoStruxure Machine Expert - Basic operates in simulator mode when a connection has been established with a simulated logic controller. In simulator mode, no physical connection to a logic controller is established; instead EcoStruxure Machine Expert - Basic simulates a connection to a logic controller and the expansion modules to run and test the program.

For more information, refer to EcoStruxure Machine Expert - Basic Simulator ([see page 264](#)).

Section 1.3

The Start Menu

What Is in This Section?

This section contains the following topics:

Topic	Page
Introduction to the Start Menu	33
Registering the EcoStruxure Machine Expert - Basic Software	34
Open Project Window	35
Project Templates Window	38
Help Window	39

Introduction to the Start Menu

Overview

The **Start Menu** has the following items:

- **New Project**
To create a new project.
- **Open Project** (*see page 35*)
To open an existing project.
- **Templates** (*see page 38*)
To create a new project using an example project as a template.
- **Help** (*see page 39*)
To display the online help, related documents, training materials, and tutorials.
- **About**
To display information about EcoStruxure Machine Expert - Basic.
- **Exit**
To exit from EcoStruxure Machine Expert - Basic.

Registering the EcoStruxure Machine Expert - Basic Software

Overview

You can use the EcoStruxure Machine Expert - Basic software for 30 days before you are required to register the software. When you register, you receive an authorization code to use the software.

Registering your EcoStruxure Machine Expert - Basic software entitles you to receive technical support and software updates.

Registering

To register your EcoStruxure Machine Expert - Basic software:

Step	Action
1	In the Start Menu , click About → Register now .
2	Follow the instructions on the Registration Wizard. Click the Help button for more details.

Open Project Window



Overview

Use the **Projects** window to create a new EcoStruxure Machine Expert - Basic project or to open an existing EcoStruxure Machine Expert - Basic, TwidoSoft, or TwidoSuite project to work with.

The right-hand area of the **Projects** window contains links to additional useful information.

Opening an EcoStruxure Machine Expert - Basic Project File

Follow these steps to open a project file:

Step	Action
1	Click Open Project on the Start Menu .
2	Do one of the following: <ul style="list-style-type: none"> Click a recent project in the Recent projects list. Click Open an existing project and select an existing EcoStruxure Machine Expert - Basic project file (*.smbp) or a sample project file (*.smbse).
3	<p>Case 1 If a window asking you to enter the password appears, it means that the project is password-protected:</p> <ol style="list-style-type: none"> Type the encryption password. Click Apply To modify the project: <ol style="list-style-type: none"> Click  on the Properties tab. Result: A window asking you to enter the password appears. Type the modification password. Click Apply. <p>Result: The project file opens and the Configuration tab is displayed.</p> <p>Case 2 If an error icon is displayed on the Properties tab, it means that the project that you want to open was password-protected in a previous version of EcoStruxure Machine Expert - Basic with View and Download selected:</p> <ol style="list-style-type: none"> Click Properties tab → Project Protection. Click  on the Properties tab. Type a password to encrypt the project. You must encrypt the project to be allowed to save it. Click Apply. <p>Case 3 If the Error window appears, it means that the project that you want to open was password-protected in a previous version of EcoStruxure Machine Expert - Basic with Download only selected:</p> <ol style="list-style-type: none"> Click OK Result: The Properties tab is displayed. Click Project Protection. Click , then enter the project password. If you want to remove the project protection, select Inactive and click Apply. If you want to keep the project protection, type the encryption password, select View and Download. Result: As the View and Download is the default mode, the check box disappears. Click Apply.

Opening a TwidoSuite or TwidoSoft Project File

EcoStruxure Machine Expert - Basic allows you to open applications created for Twido programmable controllers and convert them to EcoStruxure Machine Expert - Basic project files.

Follow these steps to open a TwidoSuite or TwidoSoft project file:

Step	Action
1	Click Open Project on the Start Menu .
2	<p>Click Open an existing project, select any of the following in the Files of type list, and then browse and select an existing project with respective extension:</p> <ul style="list-style-type: none"> ● TwidoSuite Project Files (*.xpr) ● Twido Archive Project Files (*.xar) ● TwidoSoft Project Files (*.twd) <p>If the selected Twido project file is open in TwidoSoft, TwidoSoft locks the project file and it is not possible to open it in EcoStruxure Machine Expert - Basic. Close the project in TwidoSoft before opening it in EcoStruxure Machine Expert - Basic.</p> <p>Result: The selected project file opens and the Configuration tab is displayed.</p>
3	A conversion report window appears. Thoroughly examine the conversion results in order to determine whether there are anomalies that resulted from converting from one controller platform to another. Refer to Converting Twido Projects to EcoStruxure Machine Expert - Basic (see page 283) for help on reconciling any such anomalies.
4	Optionally, change the M221 Logic Controller reference (see page 62).

NOTE: TwidoSuite uses %I0.0.1 (or %I0.0.7) as the Pulse input on the Very Fast Counter (%VFC) function block. In EcoStruxure Machine Expert - Basic the equivalent High Speed Counter (%HSC) function block uses %I0.0 (or %I0.6). Make appropriate modifications to your applications after conversion.

In general, the conversion of other controller platforms to the M221 Logic Controller and EcoStruxure Machine Expert - Basic platform is supported to the limits of the differences between those platforms. Inevitably, you must reconcile manually those differences, such as that described in the note above.

WARNING

UNINTENDED EQUIPMENT OPERATION

- Always verify that your application program operates as it did prior to the conversion, having all the correct configurations, parameters, parameter values, functions, and function blocks as required.
- Modify the application as necessary such that it conforms to its previous operation.
- Thoroughly test and validate the newly compiled version prior to putting your application into service.

Failure to follow these instructions can result in death, serious injury, or equipment damage.

Project Templates Window

Overview

You can use example projects to form the basis of new EcoStruxure Machine Expert - Basic projects.

Opening a Project Template

Follow these steps to create a new project based on a project template:

Step	Action
1	Select Templates on the Start Menu .
2	<p>Use the Search in templates text field located in the upper right-hand corner of the window to search for projects. As you type, EcoStruxure Machine Expert - Basic searches in the project name, the description of the project available in the lower of the window, and the project properties. A list of matching projects appears as you type.</p> <p>Select a project template file (*.smbe) in the Projects list and click Open Template.</p> <p>Result: A new project is created as a copy of the selected template.</p> <p>For projects that have a help file linked to the project template, click the Open Associated Help button for an Open associated help to be opened. If available, the option is highlighted below the Projects list.</p> <p>NOTE: EcoStruxure Machine Expert - Basic also provides a Vijeo-Designer application file and a System User Guide for some example projects. Read the description of the selected project in the Description area to know whether these files are provided with your project or not. If these files are provided, click Open associated folder to browse through the project template files (*.smbe) and Vijeo-Designer application files (*.vdz) in Windows Explorer.</p>

Help Window

Overview

This window contains links to additional EcoStruxure Machine Expert - Basic resources:

- The EcoStruxure Machine Expert - Basic online help system
- Related PDF documents, such as System User Guides (SUGs), training materials, Instruction Sheets, and descriptions of example applications
- E-Learning training materials
- Tutorials
- Information for converting Twido applications for use with EcoStruxure Machine Expert - Basic.

Part II

Developing EcoStruxure Machine Expert - Basic Applications

What Is in This Part?

This part contains the following chapters:

Chapter	Chapter Name	Page
2	The EcoStruxure Machine Expert - Basic Window	43
3	Properties	53
4	Configuration	59
5	Programming	63
6	Commissioning	239
7	Simulator	263
8	Saving Projects and Closing EcoStruxure Machine Expert - Basic	277

Chapter 2

The EcoStruxure Machine Expert - Basic Window

Section 2.1

Overview of the EcoStruxure Machine Expert - Basic Window

What Is in This Section?

This section contains the following topics:

Topic	Page
Toolbar Buttons	45
Status Area	47
System Settings	49
Print Reports	51











Toolbar Buttons







Introduction

The toolbar appears at the top of the EcoStruxure Machine Expert - Basic window to provide an access to frequently-used functions.

Toolbar

The toolbar has the following buttons:

Icon	Description
	Open the Start Menu.
	Create a new project (CTRL+N)
	Open an existing project (CTRL+O)
	Save the current project (CTRL+S). Click the down arrow to display a menu with additional save options.
	Print a report (CTRL+P). Click the down arrow to select the report to print (see page 51) or to configure the report content and format (see page 52).
	Cut (CTRL+X)
	Copy (CTRL+C)
	Paste (CTRL+V)
	Undo (CTRL+Z). Click once to undo the most recent action in the program editor. Click the down arrow and select an action from the list to undo all actions up to and including the selected action. You can undo up to 10 actions.
	Redo (CTRL+Y). Click once to cancel the most recent Undo action. Click the down arrow and select an action from the list to redo all actions up to and including the selected action. You can redo up to 10 actions.
	Display the System Settings (see page 49) window.

Icon	Description
	Click the down arrow and select an action from the list. Display online help or contextual help, view templates, release notes, tutorials, and e-Learning documents, or contact Schneider Electric technical support.
	Start the logic controller (CTRL+M). Only available in online mode and when the controller is not already in the <code>RUNNING</code> state.
	Stop the logic controller (CTRL+L). Only available in online mode and when the controller is in the <code>RUNNING</code> state.
	Initialize the logic controller. Only available in online mode.
	Compile the program.
	Log in (CTRL+G) to or log out (CTRL+H) from the selected controller. NOTE: The name of the selected controller appears to the left of this button.
	Launch (CTRL+B) or stop (CTRL+W) the EcoStruxure Machine Expert - Basic simulator (<i>see page 264</i>).

Status Area

Overview

The status area at the top of the main window displays information on the present system status:

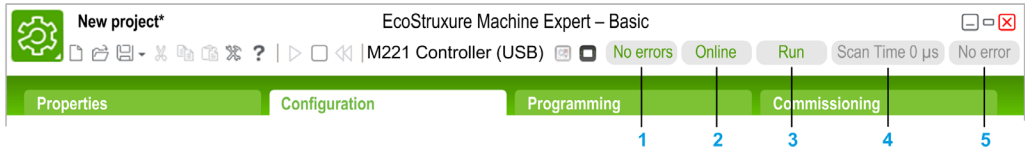

- 1 Program status:**
Indicates whether the program has errors detected or not.
- 2 Connection status:**
Indicates the connection status between EcoStruxure Machine Expert - Basic and either the logic controller or the simulated logic controller.
- 3 Controller status:**
Indicates the present state of the logic controller (RUNNING, STOPPED, HALTED, and so on).
- 4 Scan time:**
Indicates the last scan time.
- 5 Controller last error detected:**
Indicates the most recent error detected. Information is extracted from the system bits and system words if the logic controller is in STOPPED or HALTED state.

Status Area Messages

The following messages can appear in the status area:

Message Type	Possible Message	Description
Program status	[No errors]	No errors detected in the program.
	[Program advisory(ies) detected]	Program is incomplete.
	[Program error(s) detected]	No program or the program contains error(s).
Connection status	[Not connected]	EcoStruxure Machine Expert - Basic is running in offline mode.
	[Online]	EcoStruxure Machine Expert - Basic is running in online mode.

Message Type	Possible Message	Description
Controller status (only in online mode)	[Not Connected]	Controller is not connected to EcoStruxure Machine Expert - Basic.
	[Halted]	Controller is in HALTED state. Controller is stopped due to an application error being detected.
	[Stop]	Controller is in STOPPED state. Controller has a valid application which is stopped.
	[Run]	Controller is in RUNNING state. Controller is executing the application.
	[Powerless]	Controller is in POWERLESS state. Controller is powered only by the USB cable and is ready to download/upload the firmware by USB.
	[Firmware download]	Controller is downloading the firmware.
	[Firmware Error]	Firmware error detected. Version of the firmware downloading to the controller is older than present firmware version.
	[No Application]	Controller has no application.
Scan time (only in online mode)	[Scan Time 0 µs]	The most recent scan time in microseconds.
Controller last detected error (only in online mode)	[No error(s) detected]	No system error detected in the controller.
	[Controller could not switch to RUNNING state]	Controller is not OK to run.
	[Battery level low]	Controller battery is low.
	[Run/Stop input]	Controller is stopped due to Run/Stop input command.
	[Stop command]	Controller is stopped due to stop command.
	[Software error detected (exceeding the controller scan)]	Controller is halted due to software detected error. Controller scan time overshoot. Controller scan time is greater than the period defined by the user program in configuration.
	[Stop due to detected hardware error]	Controller is stopped due to detected error in the hardware.
	[Power outage]	Controller is stopped due to power outage.
	[Controller is configured in 'Start in Stop' mode]	Controller does start in automatic application execution mode due to configuration of the startup behavior.
	[Init command]	Init in cold start.
[Unknown stop reason: {0}]	Unidentified reason.	

Refer to the programming guide of the logic controller for a complete list of the system bits and system words.

System Settings

Overview

This window allows you to set the language of the EcoStruxure Machine Expert - Basic software, customize the Ladder editor, and choose the default logic controller that appears on the **Configuration** tab when you create a new project.

Changing the User Interface Language

Follow these steps to change the user interface language:

Step	Action
1	Choose System Settings → General on the System Settings window.
2	Select the language to use in the Language list. The default language is English.
3	Click Apply and close the System Settings window.
4	Close and restart EcoStruxure Machine Expert - Basic to view the user interface in the new language.

Changing Shortcuts for Help



Follow these steps to change the keyboard shortcut to access contextual or general help:

Step	Action
1	Choose System Settings → General on the System Settings window.
2	Select F1 or Shift + F1 for contextual help. The shortcut for General help is automatically updated.

Customizing the Ladder Editor

Follow these steps to customize the Ladder editor:

Step	Action
1	Choose System Settings → Ladder Editor on the System Settings window.
2	Choose the Grid lines style for the Ladder editor. <ul style="list-style-type: none"> ● Dots (default) ● Dashed Lines ● Lines
3	Set the Number of columns (11...30) for the cells in the Ladder editor. The default value of number of cells is 11. For more information, refer to Programming Principles for Ladder Diagrams (<i>see page 170</i>).

Step	Action
4	<p>Under Tool Selection Conservation, select:</p> <ul style="list-style-type: none"> ● Keep selected tool (default): After selecting and placing a graphic element in a rung, the most recently selected graphic element remains selected. This allows you to place the same element in a rung again without reselecting it. Press the ESC key or right-click an empty cell in the rung to select the pointer tool . ● Reset to pointer: After selecting and placing a contact or a coil in a rung, the pointer tool is automatically selected. To insert the same contact or coil element again, select it in the toolbar. .
5	<p>Choose the Shortcuts and toolbar style setting for the Ladder Editor:</p> <ul style="list-style-type: none"> ● Ecostruxure Machine Expert - Basic set (default) ● Asian set 1 ● Asian set 2 ● European set ● American set <p>For the selected style, the table displays a list of keyboard shortcuts for each of the toolbar buttons displayed.</p>
6	Click Apply and close the System Settings window to view the changes in the Ladder editor.

Choosing a Default Logic Controller

Follow these steps to choose a default logic controller:

Step	Action
1	Choose System Settings → Configuration on the System Settings window.
2	Click Preferred controller and choose a default logic controller from the list.
3	Click Apply and close the System Settings window.
4	Close and restart EcoStruxure Machine Expert - Basic to view the new default logic controller in the Configuration tab when a new project is created.

Print Reports

Presentation



You can generate customizable reports to print or to save in PDF format on the PC.

The **Print** button provides the following options:

- **Print Project Report** to print a customized report which can include the listing of the hardware components, the application architecture and the contents of the project, program, and application.
- **Print Bill Of Material** to print a listing of the hardware components used in the project configuration.
- **Settings** to customize the project report, allowing you to select which elements to include and the page layout.



Printing the Project Report

To print the project report:

Step	Action
1	Click the down arrow to the right of the Print button  on the toolbar and choose the Print Project Report menu command, or press CTRL+P. The Print Preview window is displayed.
2	<ul style="list-style-type: none"> ● Click  on the toolbar of the Print Preview window to print the project report. ● Click  on the toolbar of the Print Preview window to save the project report as a PDF file on the PC.

Printing the Bill Of Material

To print the **Bill Of Material**:

Step	Action
1	Click the down arrow to the right of the Print button  on the toolbar and choose the Print Bill Of Material menu command. The Print Preview window is displayed.
2	<ul style="list-style-type: none"> ● Click  on the toolbar of the Print Preview window to print the Bill Of Material. ● Click  on the toolbar of the Print Preview window to save the Bill Of Material as a PDF file on the PC.

Customizing the Project Report

To select which items to include in the project report and configure its layout:

Step	Action
1	Click the down arrow to the right of the Print button  on the toolbar and choose the Settings menu command. The Settings window is displayed.
2	Click the Report node to configure the format settings of the report (paper size, margins, and orientation).
3	<p>Select the items to include in the project report:</p> <ul style="list-style-type: none"> ● Description is the project description as in the Project Information window. ● Bill Of Material is the listing of the hardware components used in the project configuration. ● Hardware Configuration is a listing of the hardware devices used in the configuration: <ul style="list-style-type: none"> ○ IO Bus is a list of the I/O expansion modules used. ○ Cartridges is a list of the cartridges used. ● Software Configuration is to include/exclude the following items: <ul style="list-style-type: none"> ○ Constant words is a list of constant word (%KW) objects used in the project. ○ Network objects is a list of objects used to communicate with Ethernet/IP or Modbus TCP devices. ○ Software Objects lists the software objects used in the program, such as timers and counters. ○ PTO objects lists PTO function blocks used in the program. ○ Communication Objects lists the communication objects used in the program. ● Program is to include/exclude the following items: <ul style="list-style-type: none"> ○ Behavior is the settings configured in the Behavior window. ○ Memory consumption is the amount of controller memory used by the application, program, and associated user data. ○ Application architecture is the settings configured in the Master Task and Periodic Task windows. ○ POU is a listing of the POU's used in the program. ● Display is a report section containing information about the Remote Graphic Display: <ul style="list-style-type: none"> ○ General properties is the general parameters that appear on the Display tab. There is an option to print the password in your report. ○ Alarm View displays a list of triggered alarms. ○ Pages is a list of operator interface pages created on the Display tab. ● Symbols is a list of all symbols or of the symbols used in the project. ● Cross-reference is a table containing the used addresses, objects, rungs, and the line of code in which they are used. ● Animation table is a table containing the objects added to animation tables in the project.
4	Close the window.

Chapter 3

Properties

Section 3.1

Overview of the Properties Window

What Is in This Section?

This section contains the following topics:

Topic	Page
The Properties Window	55
Project Properties	56

The Properties Window

Overview

The **Properties** tab allows you to specify information about the project and whether it is to be password-protected:

- Details about the developer and the company developing the project.
- Information about the project itself.
- If the project is to be password protected, the password that must be entered correctly to open the project in EcoStruxure Machine Expert - Basic.
- If the application stored in the logic controller is to be password protected, the password that must be entered correctly to upload the application into an EcoStruxure Machine Expert - Basic project.

The screenshot shows the 'Properties' window in EcoStruxure Machine Expert - Basic. The window title is 'EcoStruxure Machine Expert - Basic'. The interface has a green header bar with tabs for 'Properties', 'Configuration', 'Programming', and 'Commissioning'. The 'Properties' tab is active. On the left, a tree view shows 'Project Properties' selected, with sub-items: 'Front Page', 'Company', 'Project Information', 'Project Protection', and 'Application Protection'. On the right, a form contains input fields for: Last Name, First Name, Phone Number, Cell Number, Email, Street, City, Zip Code (with '0' in the field), State, and Country. At the bottom right of the form are 'Apply' and 'Cancel' buttons. Two blue arrows point to the left and right panes, labeled '1' and '2' respectively.

- 1 The left hand area displays a list of the available properties.
- 2 The right hand area displays the properties of the item that is currently selected in the left hand area.

Project Properties

Overview

Use the **Properties** window to provide details about the user of EcoStruxure Machine Expert - Basic, the company developing the application, and the project. In this window, you can also password protect the project file and the application when stored in the logic controller.

Specifying Application Developer Properties

To specify the application developer properties:

Step	Action
1	Display the Properties tab and click Project Properties → Front Page .
2	Complete the information.
3	Click Apply .

NOTE: This information appears in the Windows Explorer properties window when you right-click on an EcoStruxure Machine Expert - Basic project file.

Specifying Company Properties

To specify the company properties:

Step	Action
1	Display the Properties tab and click Project Properties → Company .
2	Complete the information. To upload the company logo image, click Change then browse to select the file to upload. Click Removed to delete the current image.
3	Click Apply .

Specifying Project Information

To specify project information:

Step	Action
1	Display the Properties tab and click Project Properties → Project Information .
2	Complete the information. To upload an image, such as a photograph or CAD image of the instrumented machine, click Change then browse to select the file to upload. Click Removed to delete the current image.
3	Click Apply .

Password-Protecting a Project

It is possible to encrypt and password-protect a project file.

If a project is encrypted, you are prompted for the encryption password whenever you try to open the project.

If the project is protected against modifications, by default you can only view the project. To modify the project, type the modification password.

Follow these steps to encrypt and password-protect a project file:

Step	Action
1	Display the Properties tab and click Project Properties → Project Protection .
2	Select the Active option. Required items of information are marked with an asterisk (*).
3	Type the password and type it again as confirmation to encrypt the project.
4	Optionally, type a password and the confirmation to protect the project from modifications.
5	Click Apply .

If you want to prevent a program from being modified, create a controller image and then restore it to controller (*see page 255*).

Removing Password Protection from a Project

Follow these steps to remove password protection from a project:

Step	Action
1	Display the Properties tab and click Project Properties → Project Protection .
2	Select the Inactive option.
3	Click Apply . NOTE: If prompted to provide the modification password, type the modification password and click Apply .

Password Protecting an Application

EcoStruxure Machine Expert - Basic allows an application stored in the logic controller to be protected with a password. This password controls uploading of the application from the logic controller into an EcoStruxure Machine Expert - Basic project.

Follow these steps to password-protect an application:

Step	Action
1	Display the Properties tab and click Project Properties → Application Protection .
2	Choose the level of application protection: <ul style="list-style-type: none"> ● Select Active and leave Password blank to disable application upload from the logic controller to the PC. ● Select Active and type the same password in the Password and Confirmation fields to password protect the application. You must then enter this password when prompted before uploading the application from the logic controller to the PC.
3	Click Apply .

Removing Password Protection from an Application

Follow these steps to remove password protection from an application:

Step	Action
1	Display the Properties tab and click Project Properties → Application Protection .
2	Select the Inactive option.
3	Click Apply . NOTE: If prompted to provide the current password before the Inactive option applies successfully, type the password and click Apply .

Chapter 4

Configuration

Section 4.1

Overview of the Configuration Window

What Is in This Section?

This section contains the following topics:

Topic	Page
Overview of the Configuration Window	61
Building a Configuration	62

Overview of the Configuration Window

Introduction

Use the **Configuration** window to recreate the hardware configuration of the logic controller and expansion modules to be targeted by the program.

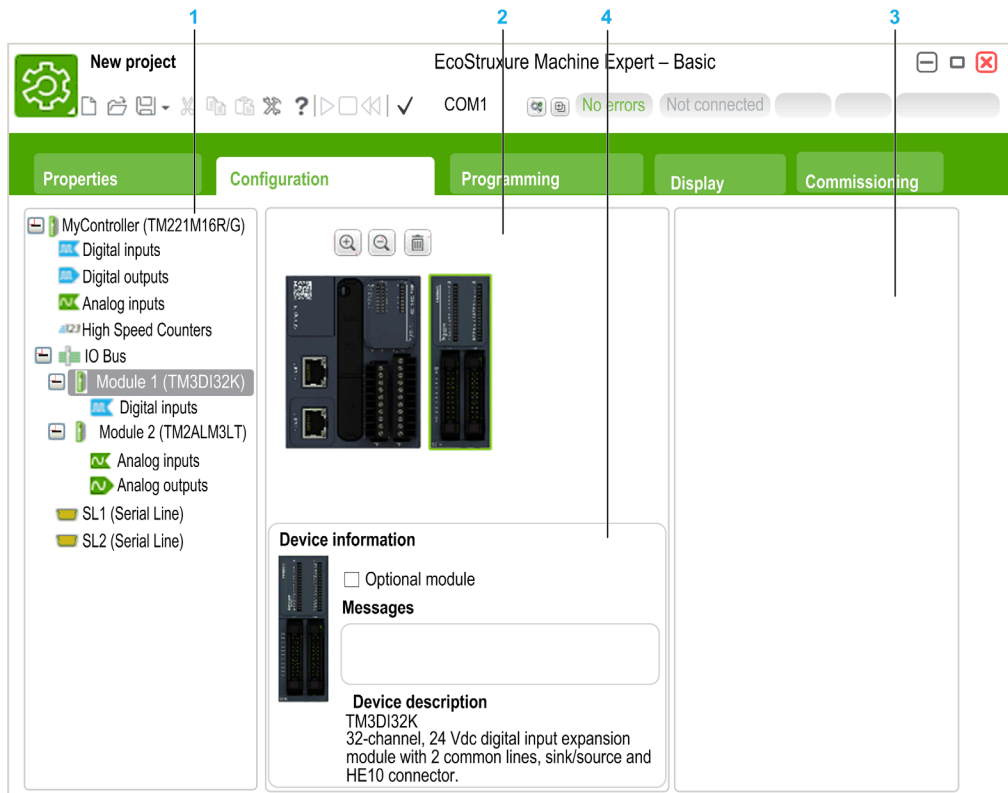

- 1 The Hardware Tree - a structured view of the hardware configuration.
- 2 The configuration - a logic controller and expansion modules.
- 3 Catalog references of the supported logic controller and expansion module hardware components. To add a component to the hardware configuration, drag and drop it onto the configuration.
- 4 The properties of the component selected in the configuration, or the properties of the selected item in the Hardware Tree.

Building a Configuration

Replacing the Default Logic Controller

When you create a new EcoStruxure Machine Expert - Basic project, a logic controller reference appears in the central area of the **Configuration** window.

Step	Action
1	Click the Configuration tab.
2	Expand the logic controller category in the catalog area on the right, if it is not already displayed.
3	Select a logic controller reference. A short description of the physical properties of the logic controller appear in the Device description area.
4	Drag the logic controller reference over the image of the existing logic controller in the central area of the window and drop it.
5	Click Yes when prompted to confirm replacing the logic controller reference.

NOTE: The default controller reference is specified in the **System Settings** window (*see page 49*).

Configuring the Logic Controller

Use the **Configuration** window to configure the logic controller.

Refer to the *Programming Guide* of the logic controller used in the configuration for details.

Configuring Expansion Modules

Use the **Configuration** window to add and configure expansion modules.

Refer to the *Programming Guide* of the expansion module used in the configuration for details.

Chapter 5

Programming

What Is in This Chapter?

This chapter contains the following sections:

Section	Topic	Page
5.1	Overview of the Programming Workspace	64
5.2	Special Functions	66
5.3	Configuring Program Behavior and Tasks	76
5.4	Managing POUs	85
5.5	User-Defined Functions	99
5.6	User-Defined Function Blocks	107
5.7	Master Task	115
5.8	Strings	119
5.9	Periodic Task	125
5.10	Event Task	129
5.11	Using Tools	136
5.12	Ladder Language Programming	167
5.13	Instruction List Programming	190
5.14	Grafcet (List) Programming	202
5.15	Grafcet (SFC) Programming	210
5.16	Debugging in Online Mode	225

Section 5.1

Overview of the Programming Workspace

Overview of the Programming Workspace

Overview

The **Programming** tab is split into 3 main areas:

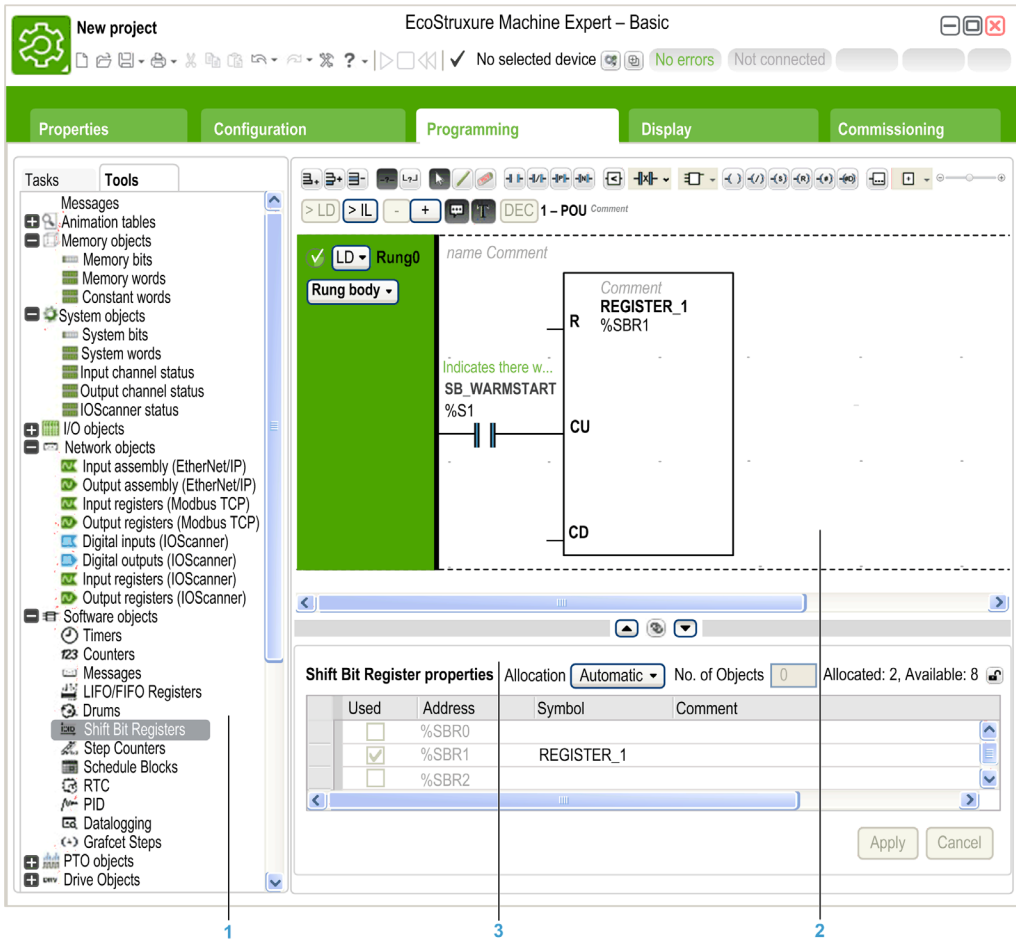

- 1 The Programming Tree allows you to select the properties of the program and its objects, and functions, as well as a number of tools which you can use to monitor and debug the program.
- 2 The upper central area is the programming workspace where you enter the source code of your program.
- 3 The lower central area allows you to view and configure the properties of the item selected in the programming workspace or the Programming Tree.

Section 5.2

Special Functions

What Is in This Section?

This section contains the following topics:

Topic	Page
Objects	67
Symbolic Addressing	68
Memory Allocation	70
Ladder/List Reversibility	71

Objects

Overview

In EcoStruxure Machine Expert - Basic, the term *object* is used to represent an area of logic controller memory reserved for use by an application. Objects can be:

- Simple software variables, such as memory bits and words
- Addresses of digital or analog inputs and outputs
- Controller-internal variables, such as system words and system bits
- Predefined system functions or function blocks, such as timers and counters.

Controller memory is either pre-allocated for certain object types, or automatically allocated when an application is downloaded to the logic controller.

Objects can only be addressed by a program once memory has been allocated. Objects are addressed using the prefix `%`. For example, `%MW12` is the address of a memory word, `%Q0.3` is the address of an embedded digital output, and `%TM0` is the address of a `Timer` function block.

Symbolic Addressing

Introduction

EcoStruxure Machine Expert - Basic supports the symbolic addressing of language objects; that is, the indirect addressing of objects by name. Using symbols allows for quick examination and analysis of program logic, and greatly simplifies the development and testing of an application.

Example

For example, `WASH_END` is a symbol that could be used to identify an instance of a `Timer` function block representing the end of a wash cycle. Recalling the purpose of this name is easier than trying to remember the role of a program address such as `%TM3`.

Defining a Symbol in the Properties Window

To define a symbol in the properties window:

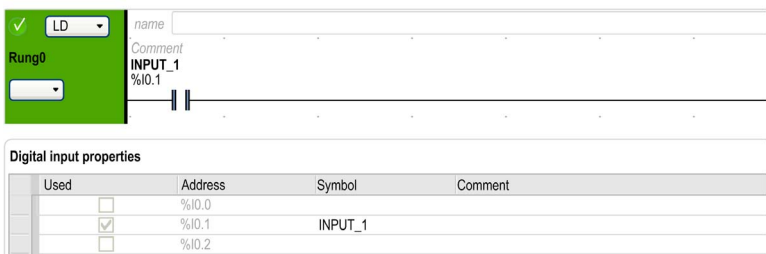
Step	Action
1	Select the Tools tab in the left-hand area of the Programming window.
2	Select the type of object with which to define a symbol, for example I/O objects → Digital inputs , to display the properties of digital inputs. The properties window of the object type appears in the lower central area of the Programming window.
3	Double-click in the Symbol column of the properties table and type the symbol to define for a particular item, for example <code>Input_1</code> for the input <code>%I0.2</code> 
4	Click Apply .

Defining a Symbol in the Ladder Editor

To define a symbol within the Ladder editor:

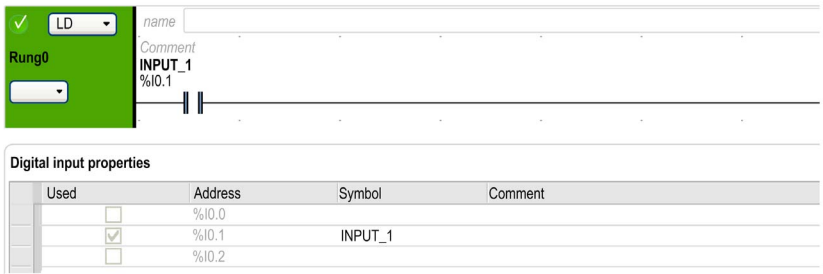
Step	Action																				
1	<p>In the Ladder editor, click the Symbol line of a graphic element, for example a latch or function block. A cursor appears:</p> 																				
2	<p>Type the symbol to use, for example <code>Input_1</code> and press Enter. The following rules apply to symbols:</p> <ul style="list-style-type: none"> • A maximum of 32 characters. • Letters (A-Z), numbers (0-9), or underscores (_). • First character must be a letter. You cannot use the percentage sign (%). • Symbols are not case-sensitive. For example, <code>Pump1</code> and <code>PUMP1</code> are the same symbol and can only be used uniquely for any given object; that is, you cannot assign the same symbol to different objects. 																				
3	<p>If the graphic element is not yet associated with an object, the Remark window appears. Select an object to associate with the symbol and click OK. Otherwise, click Yes when prompted to associate the symbol with the object.</p>																				
4	<p>Double-click either the symbol or object of the graphic element to display the symbol in the Symbol column of the properties window:</p>  <table border="1"> <thead> <tr> <th colspan="4">Digital input properties</th> </tr> <tr> <th>Used</th> <th>Address</th> <th>Symbol</th> <th>Comment</th> </tr> </thead> <tbody> <tr> <td><input type="checkbox"/></td> <td>%I0.0</td> <td></td> <td></td> </tr> <tr> <td><input checked="" type="checkbox"/></td> <td>%I0.1</td> <td>INPUT_1</td> <td></td> </tr> <tr> <td><input type="checkbox"/></td> <td>%I0.2</td> <td></td> <td></td> </tr> </tbody> </table>	Digital input properties				Used	Address	Symbol	Comment	<input type="checkbox"/>	%I0.0			<input checked="" type="checkbox"/>	%I0.1	INPUT_1		<input type="checkbox"/>	%I0.2		
Digital input properties																					
Used	Address	Symbol	Comment																		
<input type="checkbox"/>	%I0.0																				
<input checked="" type="checkbox"/>	%I0.1	INPUT_1																			
<input type="checkbox"/>	%I0.2																				

Displaying All Defined Symbols

Choose **Tools** → **Symbol list** to display a list of all defined symbols (*see page 160*).

Storing Symbols

Symbols are a part of non-program data. They are stored in the logic controller as part of an EcoStruxure Machine Expert - Basic application.

Memory Allocation

Introduction

EcoStruxure Machine Expert - Basic allows you to pre-allocate (reserve) blocks of logic controller memory for use by certain object types used in a program, including simple objects (memory words, constant words) and software objects (function blocks).

Allocation Modes

In offline mode, you can specify the memory allocation mode for each object type. When configuring these objects (**Programming → Tools**), the following window then appears above the list of configurable objects:

Allocation No. of Objects Allocated: 1, Available: 1024

Choose the memory allocation mode to use:

- **Automatic.** All objects from offset 0 to the highest memory address used in the program, or associated with a symbol, are automatically allocated in logic controller memory. For example: if the memory word `%MW20` is used in the program, all objects from `%MW0` to `%MW20` inclusive (21 objects) are automatically allocated in memory.
If you later switch to online mode, you cannot allocate new memory objects with addresses higher than the highest address that was used before you went online.
- **Manual.** Specify a number of objects to be allocated in memory in the **No. of Objects** box. When you switch to online mode, you can add new contacts, coils, or equations in your program (up to the limit of memory allocated) without having to log out from the logic controller, modify the program, log in, and download the application again.
EcoStruxure Machine Expert - Basic displays the number of objects you specified.

EcoStruxure Machine Expert - Basic displays the total number of **Allocated** memory objects and the number of memory objects **Available** in the logic controller.

If you specified the number of objects, only these objects appear in the table.

To use the multi-operand instructions, 20 `%MW` are needed and additional 20 `%MW` if using the periodic task.

Ladder/List Reversibility

Introduction

EcoStruxure Machine Expert - Basic supports conversion of rungs from Ladder Diagram to Instruction List and from Instruction List back to Ladder Diagram. This is called *program reversibility*.

In EcoStruxure Machine Expert - Basic, you can toggle rungs between programming languages at any time as required. You can therefore display a program with some rungs in Ladder Diagram and other rungs in Instruction List.

NOTE: You cannot convert Ladder and Instruction List programs to Grafcet (SFC), or Grafcet (SFC) programs to Ladder or Instruction List, or Grafcet (IL) to Grafcet (SFC).

Understanding Reversibility

A key to understanding program reversibility is examining the relationship between a Ladder Diagram rung and the associated Instruction List rung:

- **Ladder Diagram rung:** A collection of Ladder Diagram instructions that constitute a logical expression.
- **List sequence:** A collection of Instruction List programming instructions that correspond to the Ladder Diagram instructions and represents the same logical expression.

The following illustration displays a common Ladder Diagram rung and its equivalent program logic expressed as a sequence of Instruction List instructions.



Equivalent Instruction List instruction:

The screenshot shows the 'IL' (Instruction List) mode for 'Rung0'. The interface has a green sidebar with a 'Rung0' label and a 'symbols' checkbox. The main workspace displays a table of instructions:

Address	Instruction	Symbol	Comment
0000	LD	%I0.5	Comment
0001	OR	%I0.4	Comment
0002	ST	%Q0.4	Comment

A program is always stored internally as Instruction List instructions, regardless of whether it is originally written in the Ladder Diagram or Instruction List language. EcoStruxure Machine Expert - Basic takes advantage of the program structure similarities between the 2 languages and uses this internal Instruction List image of the program to display it either as an Instruction List program, or graphically as a Ladder Diagram.

Instructions Required for Reversibility

The structure of a reversible function block in Instruction List language requires the use of the following instructions:

- `BLK` marks the block start, and defines the beginning of the rung and the start of the input portion to the block.
- `OUT_BLK` marks the beginning of the output portion of the block.
- `END_BLK` marks the end of the block and the rung.

The use of these reversible function block instructions is not mandatory for a properly functioning Instruction List program.

Programming Situations and IL/Ladder Reversibility

The following table lists programming situations for the Ladder or IL languages which, if left untreated, generate advisories or errors and a possible loss of reversibility.

Situation	IL	Ladder	Rung reversible
Jump to a label which has not been defined	Error	Error	Yes
Call to undefined subroutine	Error	Error	Yes
Activate or deactivate an undefined Grafcet step	Error	Error	Yes
Jump instruction between parentheses	Error	-	No
Label between parentheses	Error	-	No
Subroutine between parentheses	Error	-	No
More than 32 nested parentheses	Error	-	No
Closing parenthesis without opening parenthesis	Error	-	No
Reserved	-	-	-
Unbalanced parentheses	Error	-	No
<code>BLK</code> without <code>END_BLK</code>	Error	-	No
<code>OUT_BLK</code> or <code>END_BLK</code> without <code>BLK</code>	Error	-	No
Label definition not followed by <code>LD</code> or <code>BLK</code>	Error	-	No
Subroutine definition not followed by <code>LD</code> or <code>BLK</code>	Error	-	No
Reserved	-	-	-
More than 11 nested <code>MPS</code>	Error	-	No
<code>MRD</code> without <code>MPS</code>	Error	-	No

Situation	IL	Ladder	Rung reversible
MPP without MPS	Error	-	No
Use Grafcet instruction in POST	Error	Error	Yes
Grafcet definition not followed by BLK or LD	Error	-	No
Unbalanced stack operations	Error	-	No
Reserved	-	-	-
Duplicate label	Error	Error	Only LD->IL
Duplicate Subroutine	Error	Error	Only LD->IL
Duplicate Grafcet step	Error	Error	Only LD->IL
Reserved	-	-	-
Duplicate POST	Error	Error	Only LD->IL
Nested FB	Error	-	No
OUT_BLK between BLK and END_BLK	Error	-	No
BLK not followed by LD	Error	-	No
LD of FB output not in OUT_BLK	Error	-	No
FB outputs used outside their respective FB structure	Error	-	No
FB outputs repeated or out of order	Error	-	No
FB inputs not in BLK before OUT_BLK	Error	-	No
FB inputs used outside their respective FB structure	Error	-	No
FB inputs repeated or out of order	Error	-	No
Label declared in BLK	Error	-	No
Subroutines declared in BLK	Error	-	No
Grafcet steps declared in BLK	Error	-	No
Attempted LD of a non FB output in OUT_BLK	Error	-	No
FB output used between BLK and END_BLK	Error	-	No
Nested subroutines	Error	Error	No
Subroutine call between MPS and MPP	Error	Error	No
Subroutine call between parentheses	Error	-	No
Reserved	-	-	-
First instruction of program not a rung delimiter	Error	-	No
Jump instruction between MPS and MPP	Error	Error	No
Rung contains syntax error	Error	-	No
Reserved	-	-	-
Reserved	-	-	-

Situation	IL	Ladder	Rung reversible
Program instructions following <code>JMP</code> or <code>END</code> unconditional instructions	Error	-	No
Rung beginning with <code>LD</code> instruction does not terminate with a conditional action instruction	Advisory	-	No
Action instruction between parentheses	Error	-	No
Stack instruction between parentheses	Error	-	No
Direct-access instructions for FB (ex: <code>"CU %C0"</code>)	Advisory	-	No
Action instructions in the input section of a FB	Error	-	No
Instructions after <code>END_BLK</code>	Error	-	No
FB outputs used with <code>AND</code> and <code>OR</code> instructions	Advisory	-	No
<code>OR</code> instruction inside a FB output not between parentheses	Advisory	-	No
Instruction preceding <code>MRD</code> or <code>MPP</code> not either a conditional action or associated with stack instructions	Advisory	-	No
Unnested <code>OR</code> between <code>MPS</code> and <code>MPP</code>	Advisory	-	No
<code>OR</code> after an action instruction	Advisory	-	No
<code>OR</code> after <code>MPS</code> , <code>MRD</code> or <code>MPP</code>	Advisory	-	No
Reserved	-	-	
Subroutine call or <code>JMPC</code> not the last action instruction of the rung	Advisory	Error	No
Canonic rung exceeds 7x11 cells in Twido, 256 x 30 cells in EcoStruxure Machine Expert - Basic	Advisory	-	No
Unconditional action instruction between <code>BLK</code> and <code>END_BLK</code>	Error	-	No
<code>OUT_BLK</code> not followed by <code>LD</code> of a valid FB output or <code>END_BLK</code>	Error	-	No
FB cannot occupy first cell	-	-	Yes
FB on top of the rung, it replaces items occupying the cells	-	-	Yes
No logic above or below a FB	-	Error	No
<code>XOR</code> in first column	-	Error	No
Contacts and horizontal connectors in last column	-	Error	No
Down connectors in last row or last column	-	Error	No
Allow only valid subroutines 0 to 63	-	Error	No
Allow only valid labels 0 to 63	-	Error	No

Situation	IL	Ladder	Rung reversible
Invalid operate expressions in operation block	-	Error	No
Invalid comparison expressions in comparison block	-	Error	No
Invalid address or symbol in contact and coil	-	Error	No
Invalid operand or expression with Ladder instruction	-	Error	No
Rung with no output action item	-	Error	No
Discontinuity between left and right power bars	-	Error	No
Dangling Ladder rung	-	Error	No
Ladder rung contains items that are short-circuited using connectors	-	Error	No
All divergences that contain only boolean logic items must converge in reverse order	-	Error	No
FB has no input associated	-	Error	No
FB output pins cannot be connected together	-	Error	No
XOR connected to power bar	-	Error	No
Subroutine call and jump not the last output action item	Advisory	Error	No
Canonic rung that contains a FB with part of the FB in the last column	-	-	No
Canonic rung exceeds 7x11 cells in Twido, 256 x 30 cells in EcoStruxure Machine Expert - Basic	Advisory	Error	No
OPEN and SHORT connected to the left node of subnetwork	-	Error	No
XOR connected to the left node of subnetwork	-	Error	No
There is not at least one existing LIST sentence that can represent the ladder rung	-	Error	No

Section 5.3

Configuring Program Behavior and Tasks

What Is in This Section?

This section contains the following topics:

Topic	Page
Application Behavior	77
Tasks and Scan Modes	82

Application Behavior

Overview

You can configure the following aspects of how the application interacts with the logic controller:

- **Startup** (*see page 77*)
- **Watchdog** (*see page 79*)
- **Fallback behavior** (*see page 79*)
- **Functional levels** (*see page 80*)

Configuring Application Behavior

Follow these steps to configure the application behavior:

Step	Action
1	Select the Tasks tab in the left-hand area of the Programming window.
2	Select the Behavior item. Result: The Behavior properties appear in the lower central area of the Programming window.
3	Modify the properties as required.
4	Click Apply to save the changes.

Startup

Specify how the program behaves following a restart of the logic controller:

- **Start In Previous State:** The logic controller starts in the state that it was in before it was stopped.
- **Start In Stop:** The logic controller does not automatically start application execution.
- **Start In Run** (default): The logic controller automatically starts application execution given run criteria, such as the presence and charge of a battery, are met.
- **Unconditional Start In Run:** The logic controller automatically starts application execution even if the controller battery is absent or discharged.

When using the Start In Run feature, the controller will start executing program logic when power is applied to the equipment. It is essential to know in advance how automatic reactivation of the outputs will affect the process or machine being controlled. Configure the Run/Stop input to help control the Start In Run feature. In addition, the Run/Stop input is designed to give local control over remote RUN commands. If the possibility of a remote RUN command after the controller had been stopped locally by EcoStruxure Machine Expert - Basic would have unintended consequences, you must configure and wire the Run/Stop input to help control this situation.

 WARNING

UNINTENDED MACHINE START-UP

- Confirm that the automatic reactivation of the outputs does not produce unintended consequences before using the Start In Run feature.
- Use the Run/Stop input to help control the Start In Run feature and to help prevent the unintentional start-up from a remote location.
- Verify the state of security of your machine or process environment before applying power to the Run/Stop input or before issuing a Run command from a remote location.

Failure to follow these instructions can result in death, serious injury, or equipment damage.

 WARNING

UNINTENDED MACHINE OR PROCESS START-UP

- Verify the state of security of your machine or process environment before applying power to the Run/Stop input.
- Use the Run/Stop input to help prevent the unintentional start-up from a remote location.

Failure to follow these instructions can result in death, serious injury, or equipment damage.

When using the Unconditional Start In Run feature, the controller will attempt to start executing program logic when power is applied to the equipment, independent of the reason the controller had previously stopped. This occurs even if there is no charge in the battery, or if the battery is not present. Therefore, the controller will start with all memory values re-initialized to zero or other predetermined default values. It is conceivable that if the controller attempts to restart, for example, after a short power outage, the values in memory at the time of the outage would be lost, and restarting the machine may have unintended consequences as there was no battery to maintain memory values. It is essential to know in advance how an unconditional start will affect the process or machine being controlled. Configure the Run/Stop input to help control the Unconditional Start In Run feature.

WARNING

UNINTENDED MACHINE OPERATION

- Conduct a thorough risk analysis to determine the effects, under all conditions, of configuring the controller with the Unconditional Start In Run feature.
- Use the Run/Stop input to help avoid an unwanted unconditional restart.

Failure to follow these instructions can result in death, serious injury, or equipment damage.

Watchdog

A watchdog is a special timer used so that programs do not overrun their allocated scan time.

The watchdog timer has a default value of 250 ms. Specify the duration of the watchdog scan task. The possible range is 10...500 ms.

Fallback Behavior

Specify the fallback behavior to use when the logic controller enters the `STOPPED` or an exception state for any reason.

Two fallback behaviors exist:

- Select **Fallback values** to set outputs to the fallback values defined in the configuration properties of embedded logic controller and expansion module outputs. This is the default. Refer to the *Programming Guide* of the logic controller or expansion module for information on configuring fallback values for outputs. Individual fallback values cannot be defined for configured Status Alarm, PTO, and `FREQGEN` outputs. The fallback value for these objects is 0 and cannot be modified.
- Select **Maintain values** to keep each output in the state it was when the logic controller entered the `STOPPED` or an exception state. In this mode, the fallback values configured for logic controller and expansion module outputs are ignored and, instead, are set to the last value assumed by the output. **Maintain values** behavior is not applied to fast outputs (HSC reflex outputs, PLS, PWM, PTO, and `FREQGEN`); the fallback value for these objects is 0.

Functional Levels

Your system could include logic controllers with different firmware versions, and therefore with different capability levels. EcoStruxure Machine Expert - Basic supports functional level management to allow you to control the functional level of your application.

When EcoStruxure Machine Expert - Basic connects to the logic controller, it reads the functional level of the:

- Logic controller firmware to authorize download of the EcoStruxure Machine Expert - Basic application to the logic controller. The functional level selected for the application must be less than or equal to the maximum functional level supported by the logic controller. If this is not the case, a message tells you to either update the firmware, or to manually downgrade the functional level of the application (by selecting a level from the Functional Levels list, see below).
- Application in the logic controller, to determine whether to authorize upload of the logic controller application to the PC running EcoStruxure Machine Expert - Basic. To authorize application upload, the functional level of the logic controller application must be less than or equal to the maximum functional level supported by the installed version of EcoStruxure Machine Expert - Basic. If this is not the case, you must upgrade EcoStruxure Machine Expert - Basic to the latest version before uploading.

The **Commissioning** window displays the functional levels of the EcoStruxure Machine Expert - Basic application and the application embedded in the connected logic controller.

Select a level from the **Functional levels** list:

- **Level 10.0:** Authorizes indexed memory bits, 200 Grafcet step objects, symbols for variables and parameters in user-defined function block.
- **Level 6.2:** Authorizes improvement of the password strategy.
- **Level 6.1:** Authorizes strings support in SMS function block.
- **Level 6.0:** Authorizes Modbus TCP IOScanner, user-defined functions, user-defined function blocks, data logging on SD card, string management, structure ladder block elements, rising and falling edge functions.
- **Level 5.1:** Authorizes security strategy modification.
- **Level 5.0:** Authorizes Modbus Serial IOScanner, Drive and RTC function blocks, multi-operand instructions.
- **Level 4.1:** Authorizes online mode enhancements, support for a modem on SL2.
- **Level 4.0:** Authorizes support for sink transistor output controllers, Grafcet (SFC), Frequency Generator, Retentive Timer, Memory Management, Remote Graphic display evolution.
- **Level 3.3:** Authorizes enhancements (PTO Motion Task, HSC evolution).
- **Level 3.2:** Authorizes enhancements to support **Optional module** feature, EtherNet/IP adapter, and %SEND_RECV_SMS function block.
- **Level 3.1:** Authorizes enhancements (**Unconditional Start In Run** feature).
- **Level 3.0:** Authorizes enhancements (communications, modem, Remote Graphic Display) to the previous level of software and hardware.

- **Level 2.0:** Authorizes any enhancements and corrections over the previous level software and firmware. For example, for Pulse Train Output (PTO) support, it would be necessary to select this functional level or greater.
- **Level 1.0:** First release of the combination of the EcoStruxure Machine Expert - Basic software and the compatible firmware version(s).

NOTE: Each successive level includes all functionality of the preceding levels.

Tasks and Scan Modes

Overview

EcoStruxure Machine Expert - Basic has the following scan modes for Master task:

- **Normal mode**
Continuous cyclic scanning mode (Freewheeling mode); a new scan starts immediately after the previous scan has completed.
- **Periodic mode**
Periodic cyclic scanning mode; a new scan starts only after the configured scan time of the previous scan has elapsed. Every scan is therefore the same duration.

EcoStruxure Machine Expert - Basic offers the following task types:

- **Master task:** Main task of the application.
Master task is controlled by continuous cyclic scanning (in normal scan mode) or by specifying the scan period of 1...150 ms (default 100 ms) in periodic scan mode.
- **Periodic task:** A short duration subroutine processed periodically.
Periodic tasks are configured by specifying the scan period of 1...255 ms (default 255 ms).
- **Event task:** A very short duration subroutine to reduce the response time of the application.
Event tasks are triggered by the physical inputs or the HSC function blocks. These events are associated with embedded digital inputs (%I0.2...%I0.5) (rising, falling or both edges) or with the high speed counters (%HSC0 and %HSC1) (when the count reaches the high speed counter threshold). You can configure 2 events for each HSC function block.

Tasks Priorities

This table summarizes the task types and their priorities:

Task Type	Scan Mode	Triggering Condition	Configurable Range	Maximum Number of Tasks	Priority
Master	Normal	Normal	Not applicable	1	Lowest
	Periodic	Software timer	1...150 ms ¹		
Periodic	Periodic	Software timer	1...255 ms ¹	1	Higher than master task and lower than event tasks
Event	Periodic	Physical inputs	%I0.2...%I0.5	4	Highest
		%HSC function blocks	2 events per %HSC object		

¹ The application must be configured with a functional level (*see page 80*) of at least Level 5.0 to be able to configure a minimum value of 1 ms. Otherwise, the minimum value is 2 ms.

Events Priorities

Refer to Event Priorities and Queues (*see page 132*).

Master Task in Normal Scan Mode

This graphic shows the relationship between master task and periodic task execution when the master task is configured in normal scan mode:

Periodic task: Periodic mode
 Master task: Normal mode

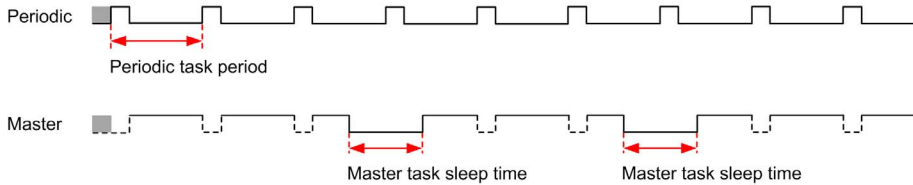

NOTE: The master task sleep time is at least 30% of the total cycle time with a minimum of 1 millisecond.

Master Task in Periodic Scan Mode

This graphic shows the relationship between master task and periodic task when the master task is configured in periodic scan mode:

Periodic task: Periodic mode
 Master task: Periodic mode

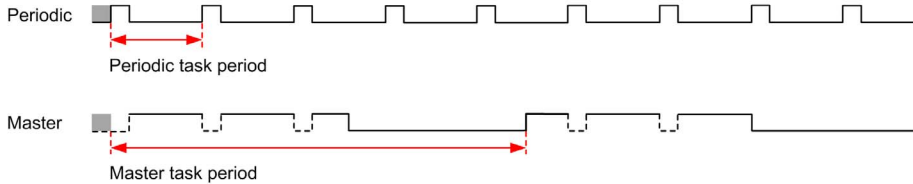

Event Priority Over Master and Periodic Tasks

Event priorities control the relationship between the event tasks, master task, and periodic task. The event task interrupts the master task and periodic task execution.

This figure shows the relationship between event tasks, master tasks, and periodic tasks in the periodic mode:

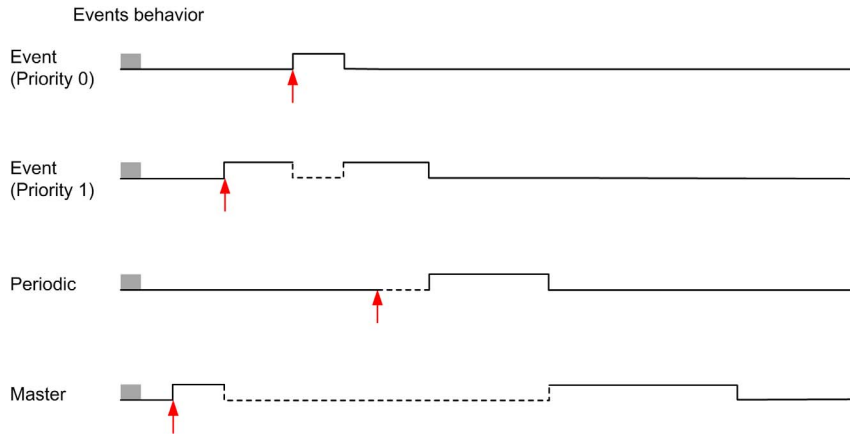

The event tasks are triggered by a hardware interruption that sends a task event to the event task.

Section 5.4

Managing POUs

What Is in This Section?

This section contains the following topics:

Topic	Page
POUs	86
Managing POUs with Tasks	87
Managing Rungs	90
Managing Grafcet (SFC) POUs	93
Free POUs	95

POUs

Overview

A Program Organization Unit (POU) is a reusable object used in a program. Each POU consists of a variable declaration and a set of instructions in the source code of a supported programming language.

One POU always exists and is linked to the master task of the program. This POU is then called automatically whenever the program starts.

You can create additional POUs containing other objects, for example, functions or function blocks.

When first created, a POU can be either:

- associated with a task (*see page 87*), or
- a Free POU (*see page 95*). A Free POU is not associated with a specific task or event. A Free POU can, for example, contain library functions that are maintained independently of the main program. Free POUs are called from within programs as either subroutines or jumps. A periodic task (*see page 126*) is a subroutine that is implemented as a Free POU.

Managing POU's with Tasks

Adding a New POU Associated with a Task

Step	Action
1	Select the Tasks tab in the left-hand area of the Programming window.
2	<p>Add a new POU by one of the following methods:</p> <ul style="list-style-type: none"> Right-click the Master Task and choose Add POU from the contextual menu that appears. Select the Master Task and click  (Add POU) on the toolbar at the top of the Tasks tab. <p>Result: A new POU is added to the program structure immediately below the default/last POU in the Master Task. The default name is <i>n</i> - New POU, where <i>n</i> is an integer incremented each time a POU is created.</p>
3	To reposition a POU in the Master Task , select a POU and click the UP or DOWN button on the toolbar at the top of the Tasks tab to move the selected POU up or down in the program structure.

Inserting a New POU

Step	Action
1	Select the Tasks tab in the left-hand area of the Programming window.
2	Select an existing POU above which to insert the POU.
3	Right-click the selected POU and choose Insert POU from the contextual menu that appears.
4	To reposition a POU in the Master Task , select a POU and click the UP or DOWN button on the toolbar at the top of the Tasks tab to move the selected POU up or down in the program structure.

Copying and Pasting Existing POU's Associated with a Task

Step	Action
1	Select the Tasks tab in the left-hand area of the Programming window.
2	<p>Select one or multiple POU's:</p> <ul style="list-style-type: none"> Select an existing POU in the Master Task. Press and hold the CTRL key and select each POU in the Master Task.
3	Right-click one of the selected POU in the Master Task and choose Copy POU from the contextual menu that appears.
4	<p>Right-click the Master Task and choose Paste POU from the contextual menu that appears.</p> <p>Result: One or multiple POU's are added to the program structure immediately below the selected POU in the Master Task with the same name as the copied POU.</p>

Exporting of POU or Free POU

Step	Action
1	Select the Tasks tab in the left-hand area of the Programming window.
2	Select one or multiple existing POU or Free POU in the Master Task
3	Right-click on the selected POU or Free POU in the Master Task and choose Export POU from the contextual menu that appears.
4	Save the POU files (*.smbf) in the Export folder that appears.

Importing of POU or Free POU

Step	Action
1	Select the Tasks tab in the left-hand area of the Programming window.
2	Select one or multiple existing POU or Free POU in the Master Task
3	Right-click on the selected POU or Free POU in the Master Task and choose Import POU from the contextual menu that appears.
4	Select the POU files (*.smbf) from the folder that appears. NOTE: If a maximum number of Free POU are reached or the file is corrupted (invalid format), an error message appears and the Free POU are not imported.

Renaming a POU



Step	Action
1	Select the Tasks tab in the left-hand area of the Programming window.
2	Edit the POU name by one of the following methods: <ul style="list-style-type: none"> ● Right-click a POU and choose Rename POU from the contextual menu that appears. ● Double-click a POU. ● Select a POU and double-click the POU name in the programming workspace. ● Select a POU and press the F2 key.
3	Type the new name for the POU and press ENTER.

Removing POU's

Step	Action
1	Select the Tasks tab in the left-hand area of the Programming window.
2	Select one or multiple POU's: <ul style="list-style-type: none">● Select an existing POU in the Master Task.● Press and hold the CTRL key and select each POU in the Master Task.
3	Delete the selected POU's: <ul style="list-style-type: none">● Right-click a selected POU in the Master Task and choose Delete POU from the contextual menu that appears.● Press the DELETE key.

Managing Rungs

Creating a Rung

Step	Action
1	Select the Tasks tab in the left-hand area of the Programming window.
2	<p>Add a rung in a POU by any of the following methods:</p> <ul style="list-style-type: none"> Right-click a POU and choose Add Rung from the contextual menu that appears. Select a POU and click  (Add Rung button) on the toolbar at the top of the Tasks tab. Select a POU and click  (Create a new Rung button) on the toolbar at the top of the programming workspace. <p>Result: A new rung is added to the program structure immediately below the last rung.</p>
3	To reposition a rung in a POU, select a rung and click the UP or DOWN button on the toolbar at the top of the Tasks tab to move the selected rung up or down in the program structure.
4	The rung is given sequence identifier, such as <code>Rung0</code> . You may additionally add a rung comment to identify the rung by clicking the rung header.
5	The default programming language is LD (ladder). To select a different programming language for this rung, click LD and choose a different programming language.
6	<p>If this rung is to be called with a <code>JUMP</code> instruction, assign a label to the rung by clicking the drop-down button below the rung sequence identifier <code>Rungx</code>, where x is the rung number in a POU, and choose <code>%L</code> from the list.</p> <p>Result: The rung is labeled as <code>%Ly</code>, where y is the label number. <code>%L</code> appears on the button and the label number y appears in suffix with the button.</p> <p>NOTE: The label number is incremented by 1 as you define the next label.</p> <p>To modify the label number, double-click the label number in a rung and enter the new number and then press ENTER.</p>

Inserting a Rung Above an Existing Rung

Step	Action
1	Select the Tasks tab in the left-hand area of the Programming window.
2	Select an existing rung in the Programming workspace.
3	<p>Click  (Insert a new Rung button) on the toolbar at the top of the programming workspace.</p> <p>Result: A new rung appears above the selected rung.</p>

Step	Action
4	The rung is given sequence identifier, such as <code>Rung0</code> . You may additionally add a rung comment to identify the rung by clicking the rung header.
5	The default programming language is LD (ladder). To select a different programming language for this rung, click LD and choose a different language.
6	<p>If this rung is to be called with a <code>JUMP</code> instruction, assign a label to the rung by clicking the drop-down button below the rung sequence identifier Rungx, where x is the rung number in a POU, and choose %L from the list.</p> <p>Result: The rung is labeled as %Ly, where y is the label number. %L appears on the button and the label number y appears in suffix with the button.</p> <p>NOTE: The label number is incremented by 1 as you define the next label.</p> <p>To modify the label number, double-click the label number in a rung and enter the new number and then press ENTER.</p>

Copying Rungs

Step	Action
1	Select the Tasks tab in the left-hand area of the Programming window.
2	Select one or multiple rungs: <ul style="list-style-type: none"> ● Select an existing rung. ● Press and hold the CTRL key and select each rung.
3	Right-click one of the selected rungs to copy and do one of the following methods: <ul style="list-style-type: none"> ● Choose Copy selected rung from the contextual menu that appears. ● Press CTRL + C.
4	Right-click a rung and do one the following methods: <ul style="list-style-type: none"> ● Choose Paste Rung from the contextual menu that appears. ● Press CTRL + V. <p>Result: A copy of the rung is inserted with the same label as the original rung. Edit the label as required.</p>



NOTE: You can also copy and paste rungs in the **Programming** window:

Step	Action
1	Right-click the rung to copy and choose Copy selected rung .
2	Right-click in the programming workspace and choose Paste Rung .

Renaming a Rung

Step	Action
1	Select the Tasks tab in the left-hand area of the Programming window.
2	Edit the rung name by one of the following methods: <ul style="list-style-type: none"> ● Right-click a rung and choose Rename Rung from the contextual menu that appears. ● Double-click a rung. ● Select a rung and double-click the rung name or the text <i>name</i> in the programming workspace. ● Select a rung and press the F2 key.
3	Type the new name for the rung and press ENTER.

Removing Rungs

Step	Action
1	Select the Tasks tab in the left-hand area of the Programming window.
2	Delete a rung by one of the following methods: <ul style="list-style-type: none"> ● Right-click a rung and choose Delete Rung from the contextual menu that appears. ● Select a rung and click  (Delete Rung button) on the toolbar at the top of the Tasks tab. ● Select a rung and click  (Delete the Rung button) on the toolbar at the top of the programming workspace. ● Right-click a rung in the programming workspace and choose Delete the selected rung from the contextual menu that appears. ● Select a rung and press the DELETE key.
3	If the rung is not empty, you are prompted to confirm deleting the rung.

Managing Grafcet (SFC) POUs

Creating a Grafcet POU

Step	Action
1	Select the Tasks tab in the left-hand area of the Programming window .
2	<p>Add a new Grafcet POU by one of the following methods:</p> <ul style="list-style-type: none"> Right-click on Master task and choose Add Grafcet POU from the contextual menu that appears. Click the  (Add Grafcet POU) button on the toolbar at the top of the Tasks tab. <p>Result: A n - Grafcet node appears below the Master task node, where n is an integer incremented each time a Grafcet POU is created.</p>

Inserting a New Grafcet POU

Step	Action
1	Select the Tasks tab in the left-hand area of the Programming window .
2	Select an existing Grafcet POU above which to insert the new Grafcet POU.
3	Right-click the selected POU and choose Insert Grafcet POU from the contextual menu that appears.
4	To reposition a Grafcet POU in the Master Task , select a Grafcet POU and click the UP or DOWN button on the toolbar at the top of the Tasks tab to move the selected Grafcet POU up or down in the program structure.

Copying and Pasting Grafcet POUs

Step	Action
1	Select the Tasks tab in the left-hand area of the Programming window .
2	<p>Select one or multiple Grafcet POUs:</p> <ul style="list-style-type: none"> Select an existing Grafcet POU in the Master Task. Press and hold the CTRL key and select each Grafcet POU in the Master Task.
3	Right-click one of the selected Grafcet POU in the Master Task and choose Copy POU from the contextual menu that appears.
4	<p>Right-click the Master Task and choose Paste POU from the contextual menu that appears.</p> <p>Result: One or multiple Grafcet POUs are added to the program structure immediately below the selected Grafcet POU in the Master Task with the same name as the copied Grafcet POU.</p>

Renaming a Grafcet POU

Step	Action
1	Select the Tasks tab in the left-hand area of the Programming window.
2	Edit the Grafcet POU name by one of the following methods: <ul style="list-style-type: none"> ● Right-click on a Grafcet POU and choose Rename POU from the contextual menu that appears. ● Double-click a Grafcet POU. ● Select a Grafcet POU and press the F2 key.
3	Type the new name for the Grafcet POU node and press ENTER.

Removing Grafcet POUs

Step	Action
1	Select the Tasks tab in the left-hand area of the Programming window.
2	Select one or multiple Grafcet POUs: <ul style="list-style-type: none"> ● Select an existing Grafcet POU in the Master Task. ● Press and hold the CTRL key and select each Grafcet POU in the Master Task.
3	Delete the selected Grafcet POUs: <ul style="list-style-type: none"> ● Right-click a selected Grafcet POU in the Master Task and choose Delete POU from the contextual menu that appears. ● Press the DELETE key.

Free POU

Introduction

In EcoStruxure Machine Expert - Basic, a Free POU is a special type of POU that is not explicitly associated with a task:

- [-] Free POU
 - [-] Free POU_0 (SR2)
 - Rung0
 - Rung1
 - [-] Free POU_1 (SR3)
 - Rung0
 - [-] Free POU_2 (SR4)
 - Rung0
 - Rung1
 - Rung2

Each Free POU is implemented as a subroutine and is made up of 1 or more rungs written in the Ladder or IL programming languages.

NOTE: Grafcet POU's cannot be Free POU's.

Free POU's are consumed when:

- Called using a subroutine call (SRi) from within a program rung
- Configured as the periodic task
- Configured as an event task, for example, the subroutine for threshold 0 of a High Speed Counter (HSC) function block (%HSCi.TH0)

When consumed as periodic or event tasks, the Free POU subroutine is automatically moved from the **Free POU's** area of the **Tasks** window to the **Periodic Task** or **Events** area of the window, respectively.

When no longer consumed as a periodic task or event task, the subroutine moves back to the **Free POU's** area and is available to be consumed by other tasks or events.

Creating a New Free POU

Proceed as follows to create a new Free POU:

Step	Action
1	Select the Tasks tab in the left-hand area of the Programming window.
2	Right-click on Free POU's and choose Add Free POU from the contextual menu that appears. Result: A new POU with the default name "Free POU_0" and default subroutine number "SR0" appears below the Free POU's branch and a new rung appears in the Programming workspace.
3	Optionally, right-click on the new POU and choose Rename POU , then type a new name for the POU and press Enter. The name of the Free POU is also updated in the rung that appears in the Programming workspace.

Step	Action
4	Optionally, type a comment (<i>see page 186</i>) to associate with the Free POU.
5	Select Subroutine number to the right of the comment box and choose a subroutine number from the list. Result: The POU description in the Free POUs list is updated with the subroutine number chosen, for example "SR11".
6	Create the rungs/steps and source code for the Free POU/Free Grafcet POU, in the Ladder or IL programming language.

Copying and Pasting Existing Free POUs

Proceed as follows to copy and paste existing POUs associated with a task to create a Free POU:

Step	Action
1	Select the Tasks tab in the left-hand area of the Programming window.
2	Select one or multiple Free POUs: <ul style="list-style-type: none"> ● Select an existing Free POU. ● Press and hold the CTRL key and select each Free POU.
3	Right-click one of the selected Free POU and choose Copy POU from the contextual menu that appears.
4	Right-click and choose Paste POU from the contextual menu that appears. Result: One or multiple new Free POUs with the name Free POU_x , where x is the next available Free POU number, and default subroutine number SRx , where x is the next available subroutine number, appear below Free POUs . All rungs of the POU are automatically associated with the new Free POU subroutine number.

Copying and Pasting Existing POUs Associated with a Task

Step	Action
1	Select the Tasks tab in the left-hand area of the Programming window.
2	Select one or multiple POUs: <ul style="list-style-type: none"> ● Select an existing POU in the Master Task. ● Press and hold the CTRL key and select each POU in the Master Task.
3	Right-click one of the selected POU in the Master Task and choose Copy POU from the contextual menu that appears.
4	Right-click the Master Task and choose Paste POU from the contextual menu that appears. Result: One or multiple POUs are added to the program structure immediately below the selected POU in the Master Task with the same name as the copied POU.

Exporting of Free POUs

Step	Action
1	Select the Tasks tab in the upper left-hand area of the Programming window.
2	Select one or multiple existing Free POUs in the Master Task .
3	Right-click on the selected Free POUs in the Master Task and choose Export POU from the contextual menu that appears.
4	Save the Export Free POU files (*.smbf) in the Export folder that appears.

Importing of Free POUs

Step	Action
1	Select the Tasks tab in the upper left-hand area of the Programming window.
2	Select one or multiple existing Free POUs in the Master Task .
3	Right-click on the selected Free POUs in the Master Task and choose Import POU from the contextual menu that appears.
4	Select the Free POU files (*.smbf) from the folder that appears, and click Open . NOTE: If a maximum number of Free POUs is reached or the file is corrupted (invalid format), an error message appears and the Free POUs are not imported.

Removing Free POUs

Proceed as follows to remove Free POUs:

Step	Action
1	Select the Tasks tab in the left-hand area of the Programming window.
2	Select one or multiple Free POUs: <ul style="list-style-type: none"> ● Select an existing Free POU. ● Press and hold the CTRL key and select each Free POU.
3	Delete the selected Free POUs: <ul style="list-style-type: none"> ● Right-click a selected Free POU and choose Delete POU from the contextual menu that appears. ● Press the DELETE key.

NOTE: Unassign (*see page 127*) a Free POU from a task before removing it.

Assigning Free POUs to Events or Periodic Tasks

By default, Free POUs and subroutines are not associated with any events or tasks.

Refer to [Creating Periodic Task \(see page 126\)](#) for information on how to associate a Free POU with a periodic task.

Refer to [Creating Event Task \(see page 133\)](#) for information on how to associate a Free POU with an event.

Section 5.5

User-Defined Functions

Overview

A user-defined function allows you to create new functions with input parameters, local variables and a return value. User-defined functions are stored as part of the EcoStruxure Machine Expert - Basic project.

You can call user-defined functions in:

- The Master task
- Periodic tasks
- Events
- Free POUs

NOTE: The application must be configured with a functional level (*see page 80*) of at least **Level 6.0** to support user-defined functions.

What Is in This Section?

This section contains the following topics:

Topic	Page
Creating a User-Defined Function	100
Defining a User-Defined Function	101
Managing User-Defined Functions	105

Creating a User-Defined Function

Adding a New User-Defined Function

You can have up to 64 user-defined functions in a project.

Step	Action
1	Select the Tasks tab in the left-hand area of the Programming window.
2	<p>Create a user-defined function using one of the following methods:</p> <ul style="list-style-type: none"> • Right-click User-defined functions and choose Add user-defined function from the contextual menu that appears. • Select User-defined functions and click  (Add user-defined-function) on the toolbar at the top of the Tasks tab. • Select an existing user-defined function, right click and choose Insert user-defined function. <p>Result: A new user-defined function is added to the program structure at the bottom of the list. If you inserted a user-defined function, the new user-defined function is above the selected one. The default name is FUNCTIONn, where n is an integer incremented each time a user-defined function is created.</p>
3	Optionally, rename the user-defined function. Refer to Renaming a User-Defined Function (see page 106).
4	Define the user-defined function. Refer to Defining a User-Defined Function (see page 101).

You create and manage rungs in a user-defined function in the same way as rungs in a POU. Refer to Managing Rungs ([see page 90](#)).

Defining a User-Defined Function

Presentation

The following illustration shows the actions that are available in the **Properties** view of the user-defined function:

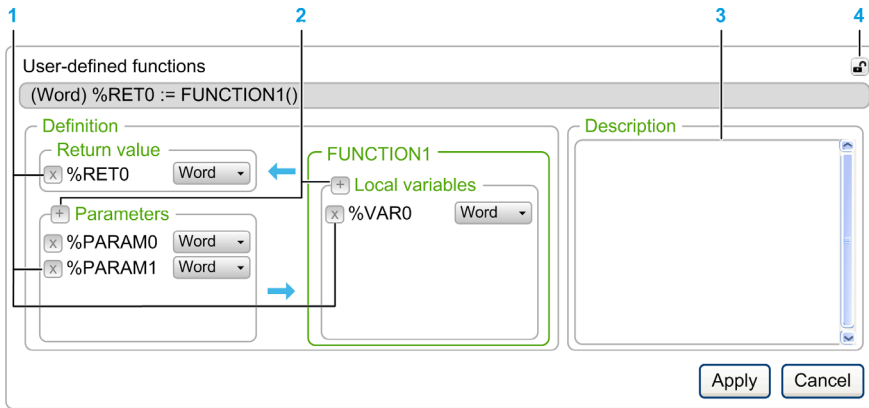

- 1 Delete the **Return value**, an input **Parameter**, or a **Local variable**
- 2 Add a **Return value**, an input **Parameter**, or a **Local variable**
- 3 Optionally, write a description of the purpose of the user-defined function. This description appears in a tooltip when you use the user-defined function in an **Operation Block** or **Comparison Block**.
- 4 Detach the properties view

Programming a User-Defined Function

To program a user-defined function:

Step	Action
1	Add a new user-defined function. Refer to Adding a User-Defined Function (<i>see page 100</i>).
2	Define the interface of the user-defined function by defining the Return value , the input Parameters and the Local variables . Refer to Defining the Interface of a User-Defined Function (<i>see page 103</i>).
3	Click Apply .
4	Define the functionality of the user-defined function in one or more Ladder/IL rungs <i>(see page 90)</i> : 1. Insert a Ladder structure element. 2. Program the user-defined function. For example: 

You can also directly program the user-defined function in the IL editor:

IL	name	Comment
Rung0	0000 LD 1	Comment
	0001 [%VAR0 := %PARAM0 + %PARAM1]	Comment
	0002 [%RET0 := %VAR0 / 2]	Comment

You can call other user-defined functions in the rungs that implement a user-defined function.

NOTE: User-defined functions cannot be recursive: a user-defined function cannot call itself directly or indirectly.

Example:

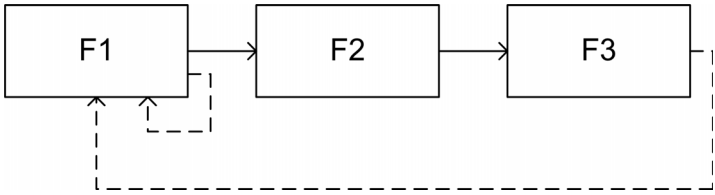

--- Not allowed

A user-defined function cannot call a subroutine, but a subroutine can call a user-defined function.

Variables and Global Variables

The three following variables can only be used in the rungs that implement the user-defined function:

- %RET0
- %PARAMn
- %VARn

Global variables are the other variables that you can use in an EcoStruxure Machine Expert - Basic program, including the rungs of a user-defined function.

Defining the Interface of a User-Defined Function

To use a user-defined function, you have to define the objects and their data types.

Object	Data Type	Description
Return value %RET0	Word Double Float	Value returned by the user-defined function. Can only be used in a rung of a user-defined function.
Parameters %PARAMn ⁽¹⁾		Parameter of a user-defined function. Can only be used in a rung of a user-defined function. You cannot change the default parameter address. You cannot add parameters to animation tables. In online mode, the current values of parameters are not displayed on IL/Ladder editor.
Local variables %VARn ⁽¹⁾		Variables used to store data values within the user-defined function. Can only be used in a rung of a user-defined function. You cannot change the default local variable address. You cannot add local variables to animation tables. In online mode, the current values of local variables are not displayed on IL/Ladder editor.
⁽¹⁾ n is an integer incremented each time a parameter or a local variable is created.		



These objects are optional.

Using User-Defined Functions

Once defined, user-defined functions can be used anywhere in the program using an **Operation Block** or **Comparison Block** in the same way as any other function.

In the Ladder editor:

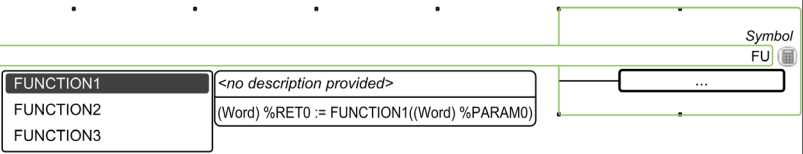
Step	Action
1	Click the Operation Block or Comparison Block button on the toolbar.
2	Click in the Action zone (<i>see page 170</i>) of the rung to insert the block.
3	Click the Selection mode  button on the toolbar.

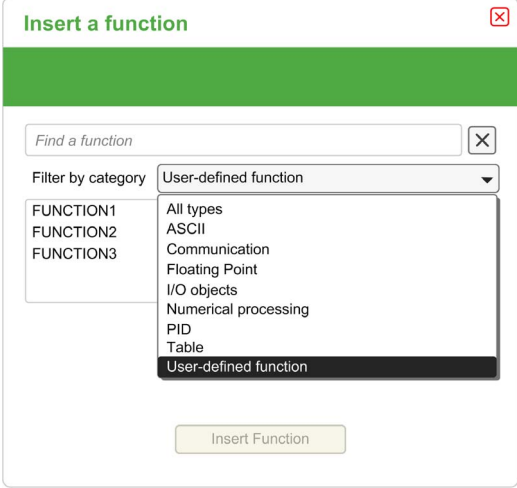
Step	Action
4	<p>Double-click the operation expression line. You can either:</p> <ul style="list-style-type: none"> Type the name of the user-defined function. For example, for the name “FUNCTION1”, type “FU” and the names of all user-defined functions that begin with “FU” appear:  <ul style="list-style-type: none"> Use Smart Coding (see page 183): <ol style="list-style-type: none"> Click the Smart Coding  button. Select Filter by category then User-defined function. Select the user-defined function. 
5	Click Insert Function .
6	Complete the definition of the user-defined function by typing the return value and the parameters as defined in Defining the Interface of a User-Defined Function (see page 103).

Managing User-Defined Functions

User-Defined Functions in Offline and Online Modes

You can manage user-defined functions in offline mode.

In online mode, you can:

- add a rung to an existing user-defined function
- modify a rung calling a user-defined function

Copying/Cutting and Pasting Existing User-Defined Functions

Step	Action
1	Select the Tasks tab in the left-hand area of the Programming window.
2	Select one or more user-defined functions: <ul style="list-style-type: none"> ● Click to select a user-defined function. ● Select multiple user-defined functions by pressing and holding the CTRL key.
3	Right-click and choose Copy user-defined functions or Cut user-defined functions from the contextual menu that appears.
4	Right-click User-defined functions and choose Paste user-defined function from the contextual menu that appears. Result: One or more user-defined functions are added at the end of the program structure in User-defined functions . EcoStruxure Machine Expert - Basic automatically assigns new name to the copied user-defined function.

Exporting User-Defined Functions

User-defined functions are stored as part of the project. If you want to use a user-defined function in another project, you have to export it, then import it to the other project.

You can copy/paste between EcoStruxure Machine Expert - Basic instances.

Step	Action
1	Select the Tasks tab in the left-hand area of the Programming window.
2	Select one or more user-defined functions: <ul style="list-style-type: none"> ● Click to select a user-defined function. ● Select multiple user-defined functions by pressing and holding the CTRL key.
3	Right-click the selected user-defined functions in User-defined functions and choose Export user-defined function from the contextual menu that appears.
4	Save the user-defined function file (*.smbf) in the Export folder that appears.

Importing a User-Defined Function

User-defined functions are stored as part of the project. If you want to use a user-defined function in another project, you have to export it, then import it to the other project.

Step	Action
1	Select the Tasks tab in the left-hand area of the Programming window.
2	Select a user-defined function in User-defined functions .
3	Right-click the selected user-defined function in the User-defined functions and choose Import user-defined function from the contextual menu that appears.
4	Navigate to the folder containing the user-defined function file (*.smbf) and select the user-defined function.
5	Confirm with OK .

Renaming a User-Defined Function

Step	Action
1	Select the Tasks tab in the left-hand area of the Programming window.
2	Rename using one of the following methods: <ul style="list-style-type: none"> • Right-click a user-defined function and choose Rename user-defined function from the contextual menu that appears. • Double-click the user-defined function in the programming workspace. • Select a user-defined function and press the F2 key.
3	Enter the new name for the user-defined function and press ENTER. The accepted characters are A...Z, 0...9, _. The name must be unique. Otherwise, the name remains unchanged.

Deleting User-Defined Functions

Step	Action
1	Select the Tasks tab in the left-hand area of the Programming window.
2	Select one or more user-defined functions by pressing and holding the CTRL key.
3	Delete the selected user-defined functions using one of the following methods: <ul style="list-style-type: none"> • Right-click a selected user-defined function in User-defined functions and choose Delete user-defined function from the contextual menu that appears. • Press the DELETE key. • Click  on the toolbar at the top of the Tasks tab.

Section 5.6

User-Defined Function Blocks

Overview

A user-defined function block allows you to create new function blocks with one or more input and output parameters, and local variables. User-defined function blocks are stored as part of the EcoStruxure Machine Expert - Basic project.

You can call user-defined function blocks in:

- The Master task
- Periodic tasks
- Events
- Free POUs

NOTE: The application must be configured with a functional level (*see page 80*) of at least **Level 6.0** to support user-defined function blocks.

What Is in This Section?

This section contains the following topics:

Topic	Page
Creating a User-Defined Function Block	108
Defining a User-Defined Function Block	109
Managing User-Defined Function Blocks	113

Creating a User-Defined Function Block

Adding a New User-Defined Function Block

Step	Action
1	Select the Tasks tab in the left-hand area of the Programming window.
2	<p>Create a user-defined function block using one of the following methods:</p> <ul style="list-style-type: none"> ● Right-click User-defined function blocks and choose Add user-defined function block from the contextual menu that appears. ● Select User-defined function blocks and click  (Add user-defined function block) on the toolbar at the top of the Tasks tab. ● Select an existing user-defined function block, right click and choose Insert user-defined function block. <p>Result: A new user-defined function block is added to the program structure immediately at the bottom of the list. If you inserted a user-defined function block, the new user-defined function block is above the selected one. The default name is UDFBn, where n is an integer incremented each time a user-defined function block is created.</p>
3	Optionally, rename the user-defined function block. Refer to Renaming a User-Defined Function Block (see page 114) .
4	Define the user-defined function block. Refer to Defining a User-Defined Function Block (see page 109) .

You create and manage a rung in a user-defined function block in the same way as a rung in a POU. Refer to [Managing Rungs \(see page 90\)](#).

Defining a User-Defined Function Block

Presentation

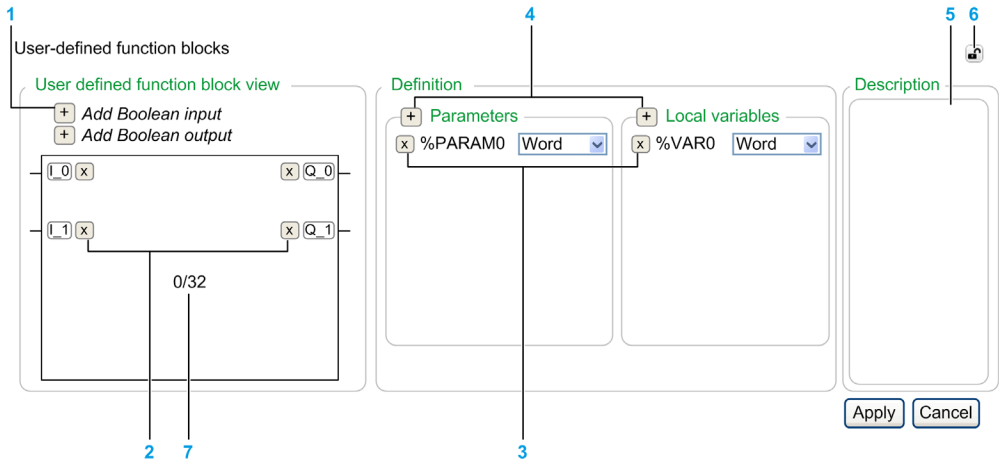

The following illustration shows the actions that are available in the **Properties** view of the user-defined function:



- 1 Add an **input** or **output**
- 2 Delete an **input** or **output**
- 3 Delete the **Parameter** or the **Local variable**
- 4 Add a **Parameter** or a **Local variable**
- 5 Optionally, write a description of the purpose of the user-defined function block. This description appears in a tooltip when you use the user-defined function block in an **Operation block**.
- 6 Detach the properties view
- 7 Number of instances in the user logic for this function block definition

Programming a User-Defined Function Block

To program a user-defined function block:

Step	Action
1	Add a new user-defined function block. Refer to Adding a User-Defined Function Block (<i>see page 108</i>).
2	Define the interface of the user-defined function block by defining the input Parameters and the Local variables . Refer to Defining the Interface of a User-Defined Function Block (<i>see page 111</i>).
3	Click Apply .
4	Specify the functionality of the user-defined function block in one or more Ladder/IL rungs (<i>see page 90</i>): <ol style="list-style-type: none"> 1. Click the Function blocks  button on the toolbar. 2. Select  → the user-defined function block you want to insert. 3. Click in the Action zone (<i>see page 170</i>) of the rung. 4. Program the user-defined function block.

You cannot program a user-defined function block in the IL editor.

Local and Global Variables

The local variables are variables that can only be used in the rungs that implement the user-defined function block:

- %PARAMn
- %VARn

Global variables are all other variables you can use in an EcoStruxure Machine Expert - Basic program, including the rungs of a user-defined function block.



Defining the Interface of a User-Defined Function Block

To use a user-defined function block you have to define the inputs, outputs, object types and their data types.

Object type	Data Type	Description
Inputs/outputs	Boolean	Input and output pins for the function block.
Parameters %PARAMn ⁽¹⁾	Word Double Float	Can only be used in a rung of a user-defined function and user-defined function block. You cannot change the default parameter address. You can add parameters to animation tables.
Local variables %VARn ⁽¹⁾		Can only be used in a rung of a user-defined function and user-defined function block. You cannot change the default local variable address. You can add local variables to animation tables.
(1) <i>n</i> is an integer incremented each time a parameter or a local variable is created.		

Using a User-Defined Function Block

To insert a user-defined function block into a rung:

Step	Action
1	Click the Function blocks  button on the toolbar.
2	Select  → the user-defined function block you want to insert.
3	Click in the Action zone (<i>see page 170</i>) of the rung.
4	<p>Optionally use operation blocks to read or write function block parameters. The syntax is %<UDFB name><instance number>.PARAMn, where n is an integer corresponding to the parameter number.</p> <p>Example:</p> <ul style="list-style-type: none"> You defined a user-defined function block named MY_FB with a parameter %PARAM0. An instance of this user-defined function block is placed in the Master task and the instance number 0 is assigned to it. <p>Result: The object %MY_FBO.PARAM0 is available in any tasks.</p>

Modifying an Existing User-defined Function Block

A user-defined function block is considered existing once it is used in your logic. This is indicated in the properties view of the user-defined function block definition (*see page 109*).

You can edit the inputs, outputs, parameters and variables of the function block in the same fashion that they were created without additional restriction.

 WARNING
UNINTENDED EQUIPMENT OPERATION
Verify all existing instances of the user-defined function block after editing any input or output definitions such that the logic of their use functions as originally intended.
Failure to follow these instructions can result in death, serious injury, or equipment damage.

Managing User-Defined Function Blocks

User-Defined Function Blocks in Offline and Online Modes

You can manage the user-defined function blocks in offline mode.

In online mode, you can:

- add a rung to an existing user-defined function block
- copy/paste a user-defined function block
- import/export a user-defined function block
- modify a rung calling a user-defined function block

Copying/Cutting and Pasting Existing User-Defined Function Blocks

Step	Action
1	Select the Tasks tab in the left-hand area of the Programming window.
2	Select one or more user-defined function blocks: <ul style="list-style-type: none"> ● Click to select a user-defined function block. ● Select multiple user-defined function blocks by pressing and holding the CTRL key.
3	Right-click and choose Copy user-defined function blocks or Cut user-defined function blocks from the contextual menu that appears.
4	Right-click User-defined function blocks and choose Paste user-defined function block from the contextual menu that appears. Result: One or more user-defined function blocks are added at the end of the program structure in User-defined function blocks . EcoStruxure Machine Expert - Basic automatically assigns new name to the copied user-defined function block.

Exporting User-Defined Function Blocks

User-defined function blocks are stored as part of the project. If you want to use a user-defined function block in another project, you have to export it, then import it to the other project.

Step	Action
1	Select the Tasks tab in the left-hand area of the Programming window.
2	Select one or more user-defined function blocks: <ul style="list-style-type: none"> ● Click to select a user-defined function block. ● Select multiple user-defined function blocks by pressing and holding the CTRL key.
3	Right-click the selected user-defined function blocks in User-defined function blocks and choose Export user-defined function block from the contextual menu that appears.
4	Save the user-defined function block file (*.smbf) in the Export folder that appears.

Importing a User-Defined Function Block

User-defined function blocks are stored as part of the project. If you want to use a user-defined function block in another project, you have to export it, then import it to the other project.

Step	Action
1	Select the Tasks tab in the left-hand area of the Programming window.
2	Select a user-defined function in User-defined function blocks .
3	Right-click the selected user-defined function in the User-defined functions blocks and choose Import user-defined function block from the contextual menu that appears.
4	Navigate to the folder containing the user-defined function block file (*.smbf) and select the user-defined function block.
5	Confirm with OK .

Renaming a User-Defined Function Block

Step	Action
1	Select the Tasks tab in the left-hand area of the Programming window.
2	Rename using one of the following methods: <ul style="list-style-type: none"> • Right-click a user-defined function block and choose Rename user-defined function block from the contextual menu that appears. • Double-click the user-defined function block's name in the programming workspace. • Select a user-defined function block and press the F2 key.
3	Enter the new name for the user-defined function block and press ENTER. The accepted characters are A...Z, 0...9, _. The name must be unique. Otherwise, the name remains unchanged.

Deleting User-Defined Function Blocks

Step	Action
1	Select the Tasks tab in the left-hand area of the Programming window.
2	Select one or more user-defined function blocks by pressing and holding the CTRL key.
3	Delete the selected user-defined function blocks using one of the following methods: <ul style="list-style-type: none"> • Right-click a selected user-defined function block in User-defined function blocks and choose Delete user-defined function block from the contextual menu that appears. • Press the DELETE key. • Click  on the toolbar at the top of the Tasks tab.

Section 5.7

Master Task

What Is in This Section?

This section contains the following topics:

Topic	Page
Master Task Description	116
Configuring Master Task	117

Master Task Description

Overview

The master task represents the main task of the application program. It is obligatory and is created by default. The master task is made up of sections and subroutines represented within Program Organizational Units (POUs). Each POU of the master task can be programmed in any of the supported programming languages.

Procedure

For	Refer To
Creating a new POU in the master task	Creating a New POU Associated with a Task (see page 87)
Renaming a POU in the master task	Renaming a POU (see page 88)
Removing a POU from the master task	Removing a POU (see page 89)

Configuring Master Task

Procedure

Follow these steps to configure the master task:

Step	Action
1	Select the Tasks tab in the left-hand area of the Programming window.
2	Select the Master Task item. Result: The Master Task properties appear in the lower central area of the EcoStruxure Machine Expert - Basic window.
3	Modify the properties as required.
4	Click Apply to save the changes.

Master Task Properties

Scan Mode

Choose the scan mode to use for the program:

- **Normal:** When a logic controller is in normal (freewheeling) scan mode, a new scan starts immediately after the previous scan has completed.
- **Periodic:** In periodic scan mode, the logic controller waits until the configured scan time has elapsed before starting a new scan. Every scan is therefore the same duration. Specify the scan **Period** for the periodic scan mode of 1...150 ms.

System Bits and Words Controlling the Master Task

The master task can be controlled by system bits (%S) and system words (%SW):

This table lists the system bits:

System Bits	Description
%S11	Watchdog overflow
%S19	Scan period overrun (periodic scan mode)

This table lists the system words:

System Words	Description
%SW0	Logic controller scan period (periodic scan mode)
%SW30, %SW70	Last scan time. Indicates the execution time of the last controller scan cycle, that is, the time elapsed between the start (acquisition of inputs) and the end (update of outputs) of a master task scan cycle. %SW30 provides the millisecond part, and %SW70 provides the microseconds part. For example, if the scan time is 2.250 ms, %SW30 = 2 and %SW70 = 250.
%SW31, %SW71	Maximum scan time. Indicates the execution time of the longest controller scan time since the last cold start of the logic controller. %SW31 provides the millisecond part, and %SW71 provides the microseconds part. For example, if the scan time is 2.250 ms, %SW31 = 2 and %SW71 = 250.
%SW32, %SW72	Minimum scan time. Indicates the execution time of the shortest controller scan time since the last cold restart of the logic controller. %SW32 provides the millisecond part, and %SW72 provides the microseconds part. For example, if the scan time is 2.250 ms, %SW32 = 2 and %SW72 = 250.

Refer to the *Programming Guide* for your hardware platform for a complete list of system bits and words and their meaning.

Section 5.8

Strings

Overview

Strings are a sequence of bytes containing ASCII characters that you can store in the following memory objects:

- Memory words %MW
- Constant words %KW

There are two bytes in one word.

Syntax to program a string:

```
%MWx : L
```

x Index of the memory object

L Number of words used by the string and must be between 1...255.

The supported controllers have a little-endian architecture; the bytes are stored from the lowest order byte to the highest.

The following table shows you an example of the storage of the bytes for the string *Basic*:

Memory objects	Hexadecimal	ASCII
%MW0 or %KW0	6142	aB
%MW1 or %KW1	6973	is
%MW2 or %KW2	0D63	\rc ⁽¹⁾
⁽¹⁾ \r is the marker representing the end character of the string. This marker is mandatory and taken into account when processing the strings.		

You can write up to 509 characters.

NOTE: The memory objects are used as a variable or for a string. If you have configured a memory object for a string, do not configure any of the memory words it contains as a variable.

What Is in This Section?

This section contains the following topics:

Topic	Page
Configuring Strings in Constant words	120
Assigning Strings in Memory Words	121
Managing Strings	122

Configuring Strings in Constant words

Entering a String

Step	Action
1	In the Programming window, click Tools → Memory objects → Constant words .
2	In Constant word properties , click %KW .
3	Click the  button in the Configuration column for the constant word that you want to configure. If the constant word is already configured the Confirmation window appears. Click Ok to overwrite the value. Otherwise, click Cancel . Result: The Constant string Assistant window appears.
4	Enter the string. Result: Range of constants required , including the termination marker, is displayed below the input text box for the string.
5	Click Apply .

Result: The entered characters are applied to the corresponding and required constant variables. The characters are inverted. Refer to the overview of this section ([see page 119](#)).

Assigning Strings in Memory Words

Syntax

The following describes Instruction List syntax. You can insert Instruction List operations and assignment instructions (*see page 182*) in Ladder Diagram rungs using an **Operation Block** graphical element.

For assigning a string in a memory word, use this syntax: `Op1 := "Your string"`.

For example:

```
%MW10:20 := "This is a Basic string."
```

If you want the software to calculate the memory space needed, type `%MWx:? := "Your string"`.

Rules of Use

When you assign a string:

- Make sure there is no overlapping. You can overwrite a string by another string.
- The use of the quotation character is not supported for immediate string assignments.

Managing Strings

Introduction

The following functions allow you to:

- Copy a string.
- Get the length of a string.
- Concatenate two strings.
- Compare two strings.

Syntax

The following describes Instruction List syntax. You can insert Instruction List operations and assignment instructions (*see page 182*) in Ladder Diagram rungs using an **Operation Block** graphical element.

Copying a String

For copying a string, use this syntax: `Op1 := Op2`.

The following table presents the authorized memory objects for Op1 and Op2:

Parameters	Description
Op1	%MWx : L
Op2	%MWy : L or %KWy : L
x, y Indexes of the memory object L must be the same for both Op1 and Op2	

Getting the Length of a String

For getting the length of a string, use this syntax: `Op1 := LENGTH(Op2)`.

The following table presents the authorized memory objects for Op1 and Op2:

Parameters	Description
Op1	%MWx
Op2	%MWy : L or %KWy : L
x, y Indexes of the memory object	

Immediate strings are not accepted.

Concatenating Two Strings

For concatenating two strings, use this syntax: `Op1 := CONCAT(Op2, Op3)`.

The following table presents the authorized memory objects for Op1, Op2 and Op3:

Parameters	Description
Op1	%MWx:L
Op2	%MWy:A or %KWy:A
Op3	%MWz:B or %KWz:B
x, y, z Indexes of the memory object	
EcoStruxure Machine Expert - Basic does not validate that L is sufficiently sized for the concatenation. Be sure that Op1 is of an adequate, minimum length for the operation.	

Immediate strings are not accepted.

The following table presents the process of concatenation:

Stage	Description
1	The application copies Op2 into Op1.
2	The copy stops if: <ul style="list-style-type: none"> • The end character of Op2 is reached. • The memory space assigned to Op2 is copied. %S28 is set to TRUE. Refer to System Bits Description. • The entire memory space of Op1 is filled. %S28 is set to TRUE.
3	If the memory space of Op1 is not filled, the application continues by copying Op3 into Op1.
4	The copy stops if: <ul style="list-style-type: none"> • The end character of Op3 is reached. • The memory space assigned to Op3 is copied. %S28 is set to TRUE. • The entire memory space of Op1 is filled. %S28 is set to TRUE.
5	The application ensures that Op1 ends with the end character. The last character of Op1 may be replaced by the end character if the memory space is filled.

Comparing Two Strings

For comparing two strings, use this syntax: `Op1 := EQUAL_STR(Op2, Op3)`.

The following table presents the authorized memory objects for Op1, Op2 and Op3:

Parameters	Description
Op1	%MWx
Op2	%MWy:A or %KWy:A
Op3	%MWz:B or %KWz:B
x, y, z Indexes of the memory object	

When the application detects a different character, Op1 equals the index position of the first different character encountered left to right.

The following table presents examples of the result of string comparison:

Op2	Op3	Different character	Op1
azerty	qwerty	First one	0
123456	124356	Third one	2
EcoStruxure Machine Expert - Basic	EcoStruxure Machine Expert - Basic	-	-1

The following table presents the process of a string comparison:

If	And if	Then
The application reaches the end character of Op2	Op2 = Op3	Op1 := -1
	Op2 ≠ Op3	Op1 equals the different character position.
The application finds a different character before reaching the end of Op2 or Op3.	-	Op1 equals the different character position.
The end of the memory space assigned to Op2 or Op3 is reached	A ≠ B	Op1 equals the different character position and %S28 is set to TRUE. Refer to System Bits Description.
	A = B	Op1 := -1 and %S28 is raised.

Section 5.9

Periodic Task

What Is in This Section?

This section contains the following topics:

Topic	Page
Creating Periodic Task	126
Configuring Periodic Task Scan Duration	128

Creating Periodic Task

Overview

A periodic task is a subroutine, usually of short duration, that is processed periodically. In EcoStruxure Machine Expert - Basic, this subroutine is implemented as a Free POU (*see page 95*). The subroutine can be written in any of the programming languages supported by EcoStruxure Machine Expert - Basic.

Assigning a Subroutine to a Periodic Task

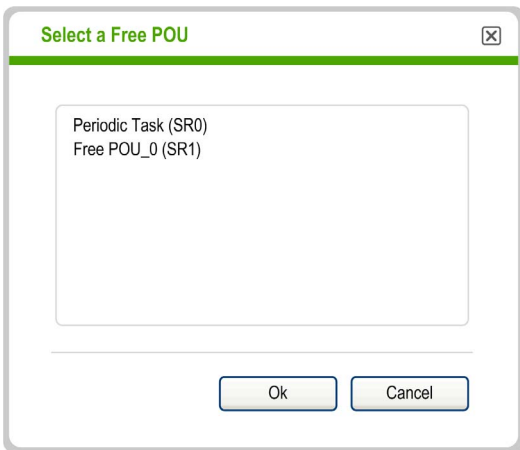
Step	Action
1	Create a new Free POU (<i>see page 95</i>) containing the periodic task subroutine.
2	Select the Tasks tab in the left-hand area of the Programming window.
3	<p>Assign a subroutine to the periodic task by one of the following methods:</p> <ul style="list-style-type: none"> • Select the Periodic Task and click  (Assign Free POU button) on the toolbar at the top of the Tasks tab. • Right-click the Periodic Task and choose Assign Free POU from the contextual menu that appears. <p>Result: The Select a Free POU window is displayed:</p>  <p>NOTE: You can directly add a Free POU to the periodic task. Right-click the Periodic Task and choose Add Free POU from the contextual menu that appears. In this case, a Free POU is created and assigned to the periodic task.</p>

Step	Action
4	<p>Select a Free POU to assign to the periodic task and click OK.</p> <p>Result: The selected subroutine is assigned to the Periodic Task and no longer available in the Free POU branch of the Tasks tab.</p> <p>For example, if the Free POU "Free POU_0" containing the subroutine SR4 is assigned to the periodic task, the Free POU_0 (%SR4) subroutine moves from the Free POU branch to the Periodic Task branch of the Tasks tab.</p>

Removing a Subroutine from a Periodic Task

Step	Action
1	Click the Tasks tab in the left-hand area of the Programming window.
2	<p>Remove the subroutine from the Periodic Task by one of the following methods:</p> <ul style="list-style-type: none"> • Select the Periodic Task and click  (Unassign Free POU button) on the toolbar at the top of the Tasks tab. • Right-click the Periodic Task and choose Unassign Free POU from the contextual menu that appears. <p>Result: The selected subroutine is removed from the Periodic Task and available as a Free POU in the Free POUs branch of the Tasks tab.</p>

Configuring Periodic Task Scan Duration

Procedure

Follow these steps to configure scan duration for periodic task:

Step	Action
1	Select the Tasks tab in the left-hand area of the Programming window.
2	Select the Periodic Task item. Result: The Periodic Task properties appear in the lower central area of the EcoStruxure Machine Expert - Basic window.
3	Modify the properties as required.
4	Click Apply to save the changes.

Periodic Task Properties

Specify the scan **Period** for the periodic task from 1...255 ms. The default value is 255 ms.

Section 5.10

Event Task

What Is in This Section?

This section contains the following topics:

Topic	Page
Overview of Event Tasks	130
Event Sources	131
Event Priorities	132
Viewing Event Tasks	133

Overview of Event Tasks

Introduction

An event task:

- Is a part of a program executed when a given condition is met (event source)
- Has a higher priority than the main program
- Produces a rapid response time, enabling the overall response time of the system to be reduced.

Description of an Event

An event is composed of:

- An *event source*: a software or hardware condition that interrupts the program when the event is triggered.
- A *POU*: an independent program entity (subroutine) associated with an event.
- A *priority level*: a priority assigned to events to determine the order in which they are executed.

Event Sources

Overview

8 event sources are available:

- 4 linked to selected physical inputs of the logic controller
- 4 linked to the HSC function block thresholds

An event source is always attached to a single event. When an event is triggered, it interrupts the controller, which then executes the subroutine associated with the event.

Physical Input Events of a Logic Controller

The embedded digital inputs %I0.2, %I0.3, %I0.4 and %I0.5 of a logic controller can be configured as event sources (filtering must be disabled).

For each of these event sources, you can choose to:

- Trigger events on detection of a rising edge, falling edge, or both rising and falling edges
- Assign a priority to the event
- Identify the subroutine associated with the event.

For further details on configuring input events, refer to the *Programming Guide* of the logic controller.

Threshold Output Event of an %HSC Function Block

The threshold outputs TH0 and TH1 of the %HSC function block can be used as event sources. Outputs TH0 and TH1 are set as follows:

- TH0 = 0 and TH1 = 0 when the value is less than threshold S0 and threshold S1
- TH0 = 1 and TH1 = 0 when the value is greater than threshold S0 and less than threshold S1
- TH0 = 1 and TH1 = 1 when the value is greater than threshold S0 and threshold S1

For each of these event sources, you can choose to:

- Trigger events on detection of a rising edge, falling edge, or both rising and falling edges.
- Assign a priority to the event.
- Identify the subroutine associated with the event.

A rising or falling edge of these outputs can activate an event process.

For further details on configuring output event, refer to the *Programming Guide* of the logic controller.

Event Priorities

Event Priorities

Events have one of 8 possible priorities, from 7 (the lowest) to 0 (the highest).

Assign a priority to each event source. Two events cannot have the same priority. Thus, the order of execution depends on their relative priorities and the order in which they are detected.

Event tasks interrupt both master and periodic task execution. For more information, refer to Event Priority Over Master and Periodic Tasks (*see page 84*).

NOTE: Care must be exercised when writing to global areas of memory or affecting I/O values when event tasks are called during the execution of other tasks. Modifying values that are otherwise used in the other tasks could affect logical outcomes of those tasks adversely.

WARNING

UNINTENDED EQUIPMENT OPERATION

Thoroughly test and validate all tasks (Master, Periodic and any Event tasks) and the interactive affect they have on one another before putting your application into service.

Failure to follow these instructions can result in death, serious injury, or equipment damage.

For configuring the event task priorities, refer to *Programming Guide* of your controller.

Event Management

Each time an interrupt linked to an event source appears, the following sequence is launched:

Step	Description
1	Interrupt event occurs.
2	Save the context.
3	Execution of the programming section (subroutine labeled SRi:) linked to the event.
4	Update the embedded outputs.
5	Restore the context.

Viewing Event Tasks

Overview

Event tasks are displayed in the **Configuration** tab. Refer to Configuring Digital Inputs.

You can display configured event sources, subroutines attached to events, and verify the status of events using system bits and words.

To display the event sources and subroutines (Free POU's) assigned to events:

Step	Action
1	Select the Tasks tab in the left-hand area of the Programming window.
2	<p>Select Events:</p> <ul style="list-style-type: none"> <input type="checkbox"/> Events <ul style="list-style-type: none"> %HSC0.TH0 : %HSC0.TH1 : %I0.2 : <input type="checkbox"/> %I0.3 : Free POU_0 <ul style="list-style-type: none"> Rung0 <p>NOTE: Configured event sources that have not yet been assigned a subroutine appear in red.</p>

NOTE: Only embedded controller inputs/outputs can be used in an event subroutine.

Assigning a Free POU to an Event Source

Proceed as follows to assign a Free POU to a configured event source:

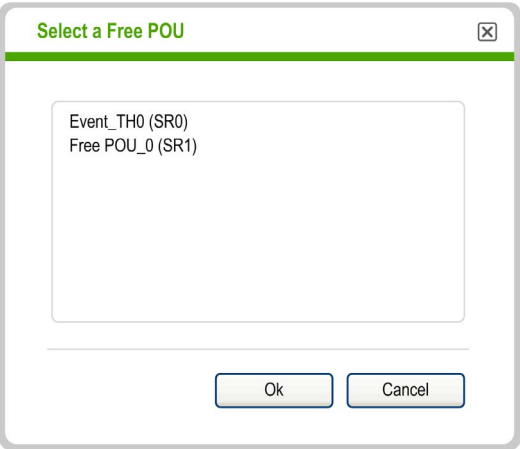
Step	Action
1	Create a new Free POU (<i>see page 95</i>) containing the subroutine to use for the event.
2	Select the Tasks tab in the left-hand area of the Programming window.
3	<p>Assign a subroutine to the event source by one of the following methods:</p> <ul style="list-style-type: none"> ● Select the event source in the Events list and click  (Assign Free POU button) on the toolbar at the top of the Tasks tab. ● Right-click the event source in the Events list and choose Assign Free POU from the contextual menu that appears. <p>Result: The Select a Free POU window is displayed:</p>  <p>NOTE: You can directly add a Free POU to the event source. Right-click the event source in the Events list and choose Add Free POU from the contextual menu that appears. In this case, a Free POU is created and assigned to the event source.</p>
4	<p>Select a Free POU to assign to the event source and click OK.</p> <p>Result: The selected subroutine is assigned to the event source and no longer available in the Free POU branch of the Tasks tab.</p> <p>For example, if the Free POU “Free POU_0” containing the subroutine SR1 is assigned to the event source, the Free POU_0 (%SR1) subroutine moves from the Free POU branch to the event source branch of the Tasks tab.</p>

Removing a Subroutine from an Event

To remove the association between a subroutine and an event source, follow these steps:

Step	Action
1	Click the Tasks tab in the left-hand area of the Programming window.
2	<p>Remove the subroutine from the event source by one of the following methods:</p> <ul style="list-style-type: none"> • Select the event source in the Events list and click  (Unassign Free POU button) on the toolbar at the top of the Tasks tab. • Right-click the event source in the Events list and choose Unassign Free POU from the contextual menu that appears. <p>Result: The selected subroutine is removed from the event source and available as a Free POU in the Free POUs branch of the Tasks tab.</p>

Checking Events with System Bits and Words

The following system bits are used to check the events:

System Bit	Description
%S38	Used to enable (%S38 = 1) or disable (%S38 = 0) events processing.
%S39	Used to determine if events are lost.

The following system words are used to check the events:

System Word	Description
%SW48	The number of events that have been executed since the last cold start of the logic controller.

The values of %S39 and %SW48 are reset to 0 and the value of system bit %S38 is set to its initial state 1 following a cold restart or after an application is loaded. Their values remain unchanged after a warm restart.

Section 5.11

Using Tools

What Is in This Section?

This section contains the following topics:

Topic	Page
Messages	137
Animation Tables	139
Memory Objects	145
System Objects	150
I/O Objects	151
Network Objects	152
Software Objects	153
PTO Objects	154
Drive Objects	155
Communication Objects	156
Search and Replace	157
Cross Reference	159
Symbol List	160
Memory Consumption View	165

Messages

Overview

While editing the program, EcoStruxure Machine Expert - Basic analyzes the source code in the **Programming** tab.



EcoStruxure Machine Expert - Basic also analyzes the program whenever the **Compile** button  on the toolbar is clicked.

If errors or advisories are detected, a clickable icon is displayed in the **Programming** tab:



Clicking on this icon opens the Messages window.

The icon that is displayed depends on the message severity:

Icon	Meaning
	Advisory. The rung is incomplete.
	A syntax error is detected.

If both advisory and error messages are detected, only the Error icon  is displayed.

The icon is also displayed in the **Tools** tab next to **Messages**:

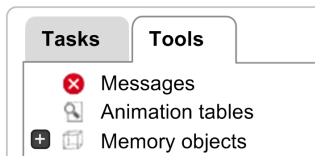

Displaying Messages

To display a list of error and advisory messages:

Step	Action
1	Click the icon on the Programming tab or: Click Tools → Messages A list of messages is displayed in the lower central area of the Programming window.
2	In the Messages area, click the Advisory button to display advisory messages, or the Error button to display error messages. Click the button again to hide the list of messages.

Rung Status

EcoStruxure Machine Expert - Basic also displays the status of each rung in the program individually.

If the rung is syntactically valid and complete, there are no messages to display and a green tick symbol is displayed:

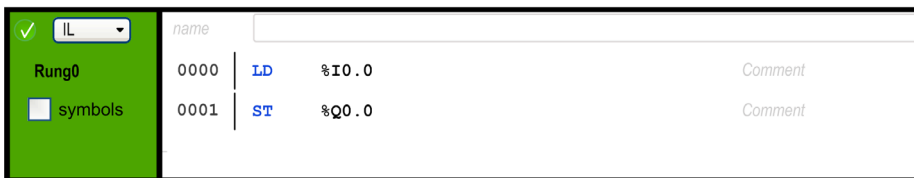

An Advisory icon appears if the rung is incomplete, for example, it does not contain a final instruction such as an END, CALL, or Jump:

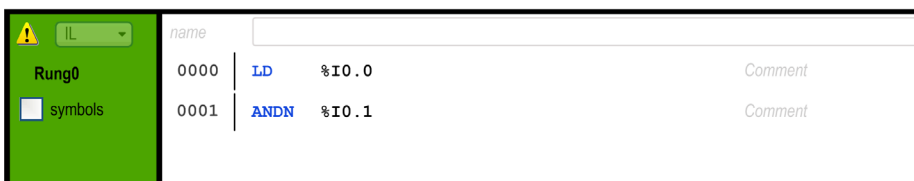

An Error icon appears if EcoStruxure Machine Expert - Basic detects one or more syntax errors that would prevent successful compilation of the rung:

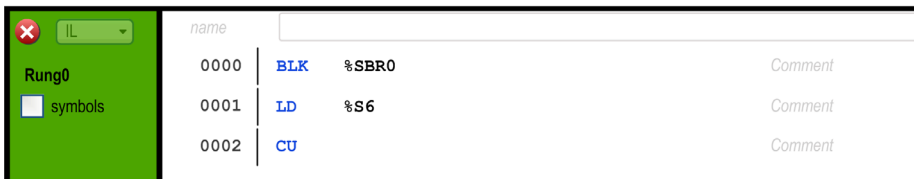

Advisory and Error icons are also displayed next to the name of each rung with errors in the **Tasks** tab:

- 1 - M_ZeroPressureAccumulator
 - Rung0
 - Rung1
 - Rung2
 - Rung3 - Rung_1
 - Rung4 - Rung_3
 - Rung5
 - Rung6 - Rung_2
 - Rung7
 - Rung8

Animation Tables

Overview

You can add objects to animation tables to:

- View symbols and comments associated with objects.
- View and modify the real-time values of certain object types when EcoStruxure Machine Expert - Basic is connected to the logic controller (online mode).
- Select objects to be displayed in the **Trace** window (*see page 226*).

Animation tables are a component of an EcoStruxure Machine Expert - Basic application, and so are downloaded to the logic controller as part of the non-program data together with the program. This allows the objects stored in animation tables to be retrieved when an application is later uploaded from the logic controller.

Animation table							
%I0.0		<input type="button" value="Add"/>	<input type="button" value="Insert"/>	Time Base	5	<input type="button" value="Open Trace window"/>	
	Used	Trace	Address	Symbol	Value	Force	Comment
	<input checked="" type="checkbox"/>	<input type="checkbox"/>	%MW50	ADDRESS_MEM	0		
	<input checked="" type="checkbox"/>	<input checked="" type="checkbox"/>	%MW610	CONTROL_CMD	0		
	<input checked="" type="checkbox"/>	<input type="checkbox"/>	%M16	MODBUS_READ	0		
	<input checked="" type="checkbox"/>	<input type="checkbox"/>	%MW61	SPEED_VALUE	0		
	<input checked="" type="checkbox"/>	<input checked="" type="checkbox"/>	%MW40	CMD	0		Control World

If you add an object that does not exist to an animation table, the **Value** field is displayed with a red outline. For example, if you add %Q1.0 but there is no corresponding digital output module in the configuration.

<input type="checkbox"/>	<input type="checkbox"/>	%Q1.0	<input style="border: 2px solid red;" type="text"/>
<input type="checkbox"/>	<input type="checkbox"/>	%M0	0

Creating an Animation Table

Step	Action
1	Select the Tools tab in the left-hand area of the Programming window.
2	Right-click Animation tables and choose Add new animation table from the contextual menu that appears. Result: A new animation table item appears below the Animation Tables area of the Tools window, and a properties window appears in the lower central area of the window.

Adding Individual Objects to an Animation Table

Step	Action
1	Select the Tools tab in the left-hand area of the Programming window.
2	Select the animation table to configure in the Animation tables area of the Tools window. Result: The properties window appears in the lower central area of the window.
3	<p>To add a new object to the bottom of the animation table, type the object name into the text box and press Enter, or click Add.</p> <p>The following objects can be added to an animation table:</p> <ul style="list-style-type: none"> ● I/O objects ● Function block objects. For example, for a Timer function block %TM0, %TM0.V, %TM0.P and %TM0.Q are automatically added to the animation table. ● Bit strings (example: %Mx:L where L is the bit count, multiple of 8) ● Word tables (example: %MWx:L where L is the word count) ● Bits of words (example: %MWx:X where X is the offset of the bit) ● Network objects (%QWE, %IWE, %QWM, %IWM) <p>NOTE: Network objects are only available if either the EtherNet/IP adapter (<i>see Modicon M221, Logic Controller, Programming Guide</i>) of the logic controller is enabled, or Modbus mapping is enabled in the Modbus TCP Configuration.</p>
4	To add a new object immediately above an existing object, select a row in the animation table, type the name of the object to add into the text box, and click Insert .

Addresses of I/O objects in animation tables are not automatically modified following configuration changes. For example, %Q3.0 is not automatically changed to %Q1.0 when the position of the corresponding module changes in the configuration. You must take into account any adjustments made to I/O memory assignments within your application and update them accordingly.

 **WARNING**

UNINTENDED EQUIPMENT OPERATION

Inspect and modify as necessary any immediate I/O addresses used in the application after modifying the configuration.

Failure to follow these instructions can result in death, serious injury, or equipment damage.

Always verify and update animation tables following a configuration change.

Adding All Objects Used in a Rung to the Animation Table

Step	Action
1	If more than 1 animation table exists, select an animation table in the Animation tables area of the Tools window. Result: The animation table properties window appears in the lower central area of the window.
2	Select the Tasks window.
3	Right-click a rung and choose Add rung objects to the current animation table from the contextual menu that appears. Result: Objects used in the rung are added to the animation table.

NOTE:

- The rung must contain no errors detected (error icon  does not appear).
- Only the first 64 objects used in the rung are added (the maximum size of an animation table).
- If the same object appears more than once in a rung, only the first occurrence is added to the animation table.

Animation Table Properties

This table describes the properties of the animation tables:

Parameter	Editable	Value	Description
Used	No	True/False	Indicates whether the object is currently being used in a program.
Trace	Yes ⁽¹⁾	True/False	Select the object to trace in the Trace window (see page 226).
Address	No	Object address	Displays the address of the object.
Symbol	No	A valid symbol	The name of the symbol associated with this object, if defined.
Value	Yes ⁽²⁾	Current value	The value of the object. If the object type has read/write access and you are in online mode (see page 31), double-click and type a new object value if required. The value of the object is updated in real time in the program running in the logic controller. See Modifying Real-Time Values (see page 229) for details.
(1) You can select up to 8 objects.			
(2) Depending on the object type, and whether you are in online mode.			

Parameter	Editable	Value	Description
Force	Yes ⁽²⁾	Force to 0 Force to 1 Not Forced	Only appears for digital inputs and digital outputs. Only editable when in online mode (<i>see page 31</i>). Allows you to force the value of the input or output to 0 or 1 as required. Choose Not Forced to remove any forcing currently applied to the address. NOTE: Forcing is performed at the end of the scan cycle. The image table of the outputs, however, may be modified due to the logic of your program, and may appear in animation tables and other data displays contrary to the forced state you selected. At the end of the scan, this will be corrected by acting upon the requested forced state and the physical output will indeed reflect that forced state.
Comment	No	A valid comment	The comment associated with this object, if defined.
(1) You can select up to 8 objects.			
(2) Depending on the object type, and whether you are in online mode.			

Configuring Items in an Animation Table

To search for and optionally replace an object in an animation table, right-click the object and choose **Search and Replace**. Refer to Search and Replace (*see page 157*) for further details.

To remove an object from an animation table, right-click the object and choose **Remove from animation table**.

Copying/Cutting and Pasting Existing Animation Tables

Step	Action
1	Select the Tools tab in the left-hand area of the Programming window.
2	Select one or more animation tables in Animation tables by pressing and holding the CTRL key.
3	Right-click one of the selected animation tables in Animation tables and choose Copy animation table or Cut animation table .
4	To paste the animation table, either: <ul style="list-style-type: none"> Right-click Animation tables and choose Paste animation table. Right-click an existing animation table and choose Paste animation table. <p>Result: The Confirmation window appears. To keep the symbols and comments, clear the check box, then click Ok.</p> <p>Result: One or more animation tables are added at the end of Animation tables or after the selected animation table.</p> <p>When copying/pasting an animation table, EcoStruxure Machine Expert - Basic automatically assigns a new name. For example: Animation_table_2 becomes Animation_table_2_0.</p>

When you paste an animation table to a project with a lower functional level (*see page 80*), only the object configurations supported by this functional level are copied.

If the symbols contained in the pasted animation table are already used in the project, EcoStruxure Machine Expert - Basic replaces the pasted symbol.

Deleting an Animation Table

Step	Action
1	Right-click the animation table to delete in the Animation tables area of the Tools window and click Delete animation table .

Renaming an Animation Table

Step	Action
1	Right-click the animation table to rename in the Animation tables area of the Tools window and click Rename animation table .
2	Type the new name of the animation table and press Enter.

Exporting Animation Tables

Step	Action
1	Select the Tools tab in the left-hand area of the Programming window.
2	To select the animation table either: <ul style="list-style-type: none"> ● Right-click Animation tables. ● Select one or more existing animation tables by pressing and holding the CTRL key, then right-click.
3	Click Export animation table .
4	Choose a folder and save the animation tables (.smbf).

Importing Animation Tables

Step	Action
1	Select the Tools tab in the left-hand area of the Programming window.
2	To select the animation table either: <ul style="list-style-type: none"> ● Right-click Animation tables. ● Right-click an existing animation table.
3	Click Import animation tables .
4	Navigate to the folder containing the animation table file (*.smbf).
5	Select the animation tables, then click Open . Result: The animation tables are added at the end of Animation tables or before the selected existing animation table.

If the symbols contained in the imported animation table are already used in the project, EcoStruxure Machine Expert - Basic replaces the imported symbol.

Opening the Trace Window

Step	Action
1	Select up to 8 objects in the Trace column of an animation table.
2	Connect (<i>see page 246</i>) to the logic controller or launch the simulator (<i>see page 264</i>).
3	Select a value in the Time Base list. This determines the refresh frequency of the Trace window (<i>see page 226</i>), in seconds.
4	Click Trace . The Trace window is displayed.

Memory Objects

Overview

Memory objects include:

- Memory bits
- Memory words
- Constant words

Selecting the Memory Allocation Mode

Before viewing or updating the properties of memory objects, choose the memory allocation mode (*see page 70*) to use.

Displaying the Used Memory Objects

To display the used memory objects, select the **Table view** check box.

Memory Bit Properties

This table describes each parameter of the **Memory bits** screen:

Parameter	Editable	Value	Default Value	Description
Used	No	True/False	False	Indicates whether the memory bit is currently being used in a program.
Address	No	Refer to Bit Objects	N/A	Displays the address of the memory bit, where <i>x</i> is the number of memory bits supported by the logic controller.
Symbol	Yes	A valid symbol	<i>None</i>	Allows you to associate a symbol with this memory bit.
Value	Yes	Refer to Bit Objects.	0	The value of this memory bit.
Comment	Yes	A valid comment	None	Allows you to associate a comment with this memory bit

Memory Word Properties



First choose the memory word type to display properties for:

- **%MW**. Memory words
- **%MD**. Double words
- **%MF**. Floating-point words

This table describes the properties of **Memory words**:

Parameter	Editable	Value	Default Value	Description
Used	No	True/False	False	Indicates whether the memory word is currently being used in a program.
Equ Used	No	True/False	False	Equivalent used. Indicates whether part of the memory area of the memory word is currently being used. Refer to Possibility of Overlap Between Objects (<i>see EcoStruxure Machine Expert - Basic, Generic Functions Library Guide</i>).
Address	No	Refer to Word Objects (<i>see EcoStruxure Machine Expert - Basic, Generic Functions Library Guide</i>)	N/A	Displays the address of the memory word.
Symbol	Yes	A valid symbol	None	Allows you to associate a symbol with this memory word.
Value	Yes	Refer to Word Objects (<i>see EcoStruxure Machine Expert - Basic, Generic Functions Library Guide</i>).	0	The value of this memory word.
Comment	Yes	A valid comment	None	Allows you to associate a comment with this memory word.

Constant Word Properties



First choose the constant word type to display properties for:

- **%KW**. Constant words.
- **%KD**. Double constant words
- **%KF**. Floating-point constant words.

This table describes each parameter of the **Constant words** screen:



Parameter	Editable	Value	Default Value	Description
Used	No	True/False	False	Indicates whether the constant word is currently being used in a program.
Equ Used	No	True/False	False	Equivalent used. Indicates whether part of the memory area of the constant word is currently being used. Refer to Possibility of Overlap Between Objects (<i>see EcoStruxure Machine Expert - Basic, Generic Functions Library Guide</i>).
Address	No	Refer to Word Objects (<i>see EcoStruxure Machine Expert - Basic, Generic Functions Library Guide</i>)	N/A	Displays the address of the constant word.
Symbol	Yes	A valid symbol	None	Allows you to associate a symbol with this constant word.
Decimal	Yes	Decimal representation of the value. Refer to Word Objects (<i>see EcoStruxure Machine Expert - Basic, Generic Functions Library Guide</i>)	0	The decimal value of this constant word.
Binary	Yes	Binary representation of the value. Refer to Word Objects (<i>see EcoStruxure Machine Expert - Basic, Generic Functions Library Guide</i>)	2#0000000000000000	The binary value of this constant word.
Hexadecimal	Yes	Hexadecimal representation of the value. Refer to Word Objects (<i>see EcoStruxure Machine Expert - Basic, Generic Functions Library Guide</i>)	16#0000	The hexadecimal value of this constant word.

Parameter	Editable	Value	Default Value	Description
ASCII	Yes	ASCII representation of the value. Refer to Word Objects (see <i>EcoStruxure Machine Expert - Basic, Generic Functions Library Guide</i>)	no meaning	The ASCII value of this constant word.
Comment	Yes	A valid comment	None	Allows you to associate a comment with this constant word.



Exporting/Importing the Constant Word Properties

You can export into a CSV file and import the **Address**, **Symbol**, **Value**, and **Comment** properties in offline or online mode.

Exporting the constant word properties:

Step	Action
1	Select the Tools tab in the left-hand area of the Programming window.
2	Click Memory objects → Constant words .
3	In Constant word properties , click Export . Result: The Export constants window appears.
4	In the Export constants window: <ol style="list-style-type: none"> 1. Select the Export type. 2. Choose the File path by clicking . 3. Enter: <ul style="list-style-type: none"> ○ The File name, ○ The First index (numeric), ○ The Last index (numeric). The First index must be less than or equal to the Last Index.
5	To modify the export parameters, click  Export options : <ol style="list-style-type: none"> 1. Select Headers if you want to display the name of the headers. 2. Choose Semicolon or Comma as separator.
6	Click Export .

Importing the constant word properties:

Step	Action
1	Select the Tools tab in the left-hand area of the Programming window.
2	Click Memory objects → Constant words .
3	In Constant word properties , click Import . Result: The window Import constants appears.
4	Click  and navigate to the folder containing the file (*.csv) and double-click the file.
5	To modify the import parameters, click  Import options and choose the separator used in the .csv file: Semicolon or Comma .
6	Click Import .

In case of duplicate values, the last duplicate value is imported.

System Objects

Overview

System objects are specific to the logic controller. For details, refer to the *Programming Guide* of your logic controller.

I/O Objects

Overview

The following object types are hardware-specific and depend on the logic controller being used:

- Digital inputs and outputs
- Analog inputs and outputs
- Advanced function blocks such as fast counters, high-speed counters, and pulse generators.

For more details, refer to the *Programming Guide* and *Advanced Functions Library Guide* of your logic controller.

Network Objects

Presentation

Network objects are used to communicate via EtherNet/IP, Modbus TCP, or Modbus Serial I/O Scanner.

There are two types of network object for EtherNet/IP communication:

- %QWE: Input Assembly
- %IWE: Output Assembly

There are two types of network object for Modbus TCP communication:

- %QWM: Input registers
- %IWM: Output registers

The following types of network object are used for the Modbus Serial I/O Scanner:

- %IN: Digital inputs (IOScanner)
- %QN: Digital outputs (IOScanner)
- %IWN: Input registers (IOScanner)
- %QWN: Output registers (IOScanner)
- %IWNs: IOScanner Network Diagnostic Codes

NOTE: References to input and output are from the point of view of the EtherNet/IP master or Modbus TCP client.

For more information on how to configure network objects, refer to the programming guide for your logic controller.

Software Objects

Overview

EcoStruxure Machine Expert - Basic supports the following generic software objects:

Object	Description
Timers	Used to specify a period of time before doing something, for example, triggering an event.
Counters	Provides up and down counting of events.
Messages	Allows communication with external devices.
LIFO/FIFO Registers	A memory block that can store up to 16 words of 16 bits each in FIFO or LIFO modes.
Drums	Operates on a principle similar to an electromechanical Drum Controller, which changes step according to external events. On each step, the high point of a cam gives a command which is executed by the logic controller.
Shift Bit Registers	Provides a left or right shift of binary data bits (0 or 1).
Step Counters	Provides a series of steps to which actions can be assigned.
Schedule Blocks	Used to control actions at a predefined month, day, and time.
RTC	Used to read the time and date from the RTC, or update the RTC in the logic controller with a user-defined time and date.
PID	Allows regulation of the Proportional Integral Derivative (PID) function.
Data Logging	Allows to permanently store data from objects or strings.
Grafcet Steps	Lists the Grafcet bit address (%Xi) variables in order to add or modify symbols or comments.

These function blocks are described in the EcoStruxure Machine Expert - Basic Generic Functions Library Guide (*see EcoStruxure Machine Expert - Basic, Generic Functions Library Guide*).

Selecting the Memory Allocation Mode

Before viewing or updating the properties of software objects, choose the memory allocation mode (*see page 70*) to use.

PTO Objects

Overview

The PTO objects provide the function blocks used for programming the PTO functions. The PTO function blocks are categorized as:

- Motion task tables
Allows you to configure individual PTO movements in an ordered sequence, and visualize an estimated global movement profile.
- Motion
These function blocks control motions of the axis. For example, power to axis, movement of the axis, and so on.
- Administrative
These function blocks control the status and diagnostics of the axis movement. For example, status and value of actual velocity, actual position, axis control detected errors, and so on.

For more details on the PTO function blocks, refer to the *Advanced Function Library Guide* of your controller.

Drive Objects

Overview

Drive objects control ATV drives and other devices configured on the Modbus Serial IOScanner or Modbus TCP IOScanner.

Refer to the *Advanced Functions Library Guide* of your logic controller.

Communication Objects

Overview

Communication objects are used to communicate with Modbus devices, send/receive messages in character mode (ASCII), and to send/receive SMS messages.

For details, refer to the chapter Communication Objects.

Search and Replace

Overview

Search and Replace allows you to find all occurrences of an object used anywhere in a program and optionally replace it with a different object.

Searching and Replacing Items

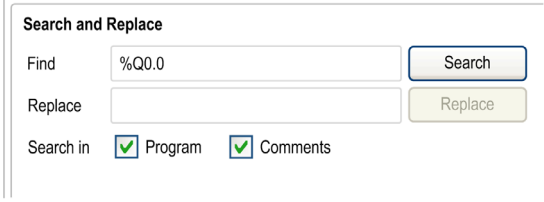
Step	Action
1	Select the Tools tab in the left-hand area of the Programming window. It is also possible to invoke the search and replace function from various other locations in EcoStruxure Machine Expert - Basic, for example, by right-clicking on an entry in an animation table (<i>see page 139</i>) and selecting Search & Replace .
2	<p>You can use any of the following methods to display the Search and Replace window:</p> <ul style="list-style-type: none"> • Click Search and Replace in the Tools tab of the Programming window. • Right-click on a rung or a selected item in the rung and click Search and Replace in the context menu that appears. • Right-click on a line in the properties window of any object and click Search and Replace in the context menu that appears. <p>This graphic shows the Search and Replace window:</p>  <p>The screenshot shows a dialog box titled "Search and Replace". It has a "Find" text box containing "%Q0.0" and a "Search" button. Below it is a "Replace" text box and a "Replace" button. At the bottom, there is a "Search in" section with two checked checkboxes: "Program" and "Comments".</p>
3	<p>In the Find box type the object or symbol name to find. The Find field is pre-filled if the search was started by right-clicking on a selected item in a rung or an item in a properties window of an object.)</p> <p>You can use the following wildcard characters:</p> <ul style="list-style-type: none"> • Asterisk (*). Replaces 0 or more characters in the search term. For example, %MW1* would find both %MW1 and %MW101. • Question mark (?). Replaces exactly 1 character in the search term. For example, typing COIL?2 would find COIL12 but not COIL012
4	Optionally, in the Replace box type a replacement object or symbol name.
5	Select Program to search for the item within the source code of the current program. Select Comments to search for the item within program comments.

Step	Action									
6	<p>Click Search or Replace. You can also press ENTER to start the search. Replace button is enabled only when the replacement object or symbol name is given in the Replace box. All items found are listed in the Results list:</p> <p>Results <input type="checkbox"/> Show symbols</p> <table border="1" data-bbox="322 342 1156 451"> <thead> <tr> <th>POU</th> <th>Rung</th> <th>Code</th> </tr> </thead> <tbody> <tr> <td>POU_0</td> <td>Rung_0</td> <td>%Q0.0</td> </tr> <tr> <td>POU_0</td> <td>Rung_1</td> <td>LD %Q0.0</td> </tr> </tbody> </table>	POU	Rung	Code	POU_0	Rung_0	%Q0.0	POU_0	Rung_1	LD %Q0.0
POU	Rung	Code								
POU_0	Rung_0	%Q0.0								
POU_0	Rung_1	LD %Q0.0								
7	<p>Optionally, select Show symbols to display instead any symbols defined for objects:</p> <p>Results <input checked="" type="checkbox"/> Show symbols</p> <table border="1" data-bbox="322 558 1156 667"> <thead> <tr> <th>POU</th> <th>Rung</th> <th>Code</th> </tr> </thead> <tbody> <tr> <td>POU_0</td> <td>Rung_0</td> <td>OUTPUT</td> </tr> <tr> <td>POU_0</td> <td>Rung_1</td> <td>LD OUTPUT</td> </tr> </tbody> </table>	POU	Rung	Code	POU_0	Rung_0	OUTPUT	POU_0	Rung_1	LD OUTPUT
POU	Rung	Code								
POU_0	Rung_0	OUTPUT								
POU_0	Rung_1	LD OUTPUT								
8	<p>Click on any of the listed results to jump directly to the line of code in the program.</p>									

Cross Reference

Overview

The cross reference view allows to display the program contained in a POU. If an object depends on another object of the same POU, the corresponding rungs are displayed.

The cross reference view is available in both offline and online modes.

Displaying the Cross Reference View

To display the cross reference view, click **Programming** → **Tools** → **Cross Reference**, then select one or several objects in the action zone.

Cross Reference View

POU	Rung	Code view	Symbol view
ElementName - %MW4 (1 items)			
1 - My POU	Rung0	[%MW4 := 5]	[%MW4 := 5]

The following table presents the element of the cross reference view:

Element	Description
POU	Name of the POU containing the object.
Rung	Name of the rung containing the object.
Code view	Programming code of the object.
Symbol view	Symbol of the object.

Symbol List

Overview

You can display a list of all the symbols that have been associated with objects in your program. All objects with symbols are displayed, with the exception of symbols automatically associated with system bits (%S) and system words (%SW). You can overwrite symbols and comments on system bits (%S) and system words (%SW) using the System Objects properties, or by importing your own symbols list (see below). Overwritten symbols then appear in the symbol list.

Defining and Using Symbols (*see page 68*) describes how to create symbols and use them in your programs.

Displaying the Symbol List

Step	Action
1	Select the Tools tab in the left-hand area of the Programming window.
2	<p>Click Symbol list.</p> <p>Result: The Symbol list window is displayed. For each item the following information is displayed:</p> <ul style="list-style-type: none"> ● Used: Whether the symbol is currently being used in the program. ● Address: The address of the object with which the symbol is associated. ● Symbol: The symbol name. ● Comment: The comment associated with this object, if defined. ● Assign symbol: EcoStruxure Machine Expert - Basic automatically assigns a symbol to each object used without symbol of the following types: %M, %MW, %MD, %MF, %S, %SW, %KW, %I, %IW, %Q, and %QW. ● Delete default symbols: Deleting default symbols assigned. ● Import: Importing symbols. ● Export: Exporting symbols.

Creating Default Symbols

To create default symbols for memory objects:

1. Click **Assign symbol**.

Result: Default symbols are assigned to all memory objects (%M, %MW, %MD, %MF, %S, %SW, %KW, %KD, %KF, %I, %IW, %Q, %QW) used in the program that do not already have symbols defined.

Symbols are named as follows: `symbolname = objectname_i`, where `objectname` is the object type without the % and `i` is the index of the object.

Example: The following objects are used in the program but have no symbols defined:

Object	Symbol Assigned
%MW0	MW_0
%MW2	MW_2
%M0	M_0

Deleting Default Symbols

To delete default symbols:

Step	Action
1	Click Delete default symbols .
2	Click Yes on the confirmation window that appears. Result: All default symbols assigned are deleted.

NOTE: If an object with a default symbol assigned is no longer used in the program, it retains its default symbol.

Importing Symbols

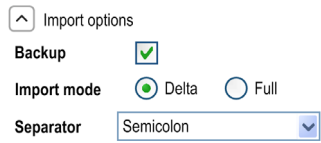
Step	Action
1	Either click the Import button or right-click anywhere in the list of symbols and choose Import symbols . Result: The Import Symbols window is displayed.
2	Browse and select the File path of the Comma Separated Values (CSV) file containing the symbols to import.
3	Optionally, click Import options and configure formatting options for the imported symbols: 

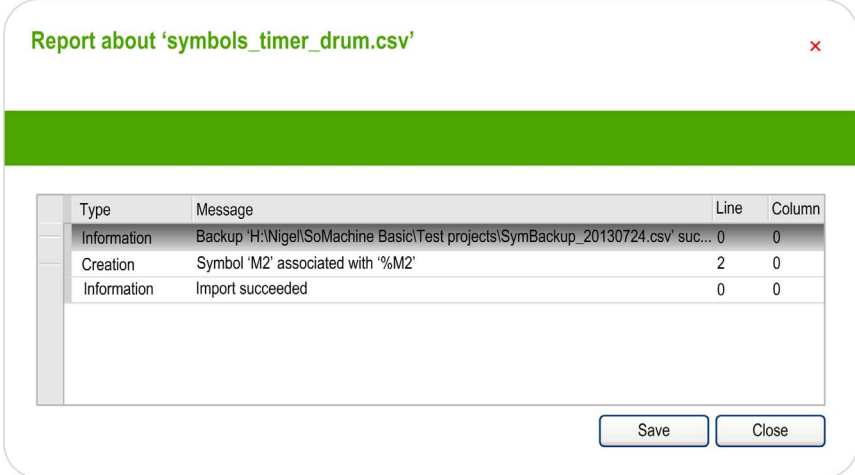
Step	Action
4	<p>Click Import.</p> <p>Result: All symbols in the selected CSV file are created and displayed in the Symbol list window with the specified formatting options. If errors are detected during import, a report is displayed listing them:</p> 
5	Click Save to write the contents of the report to a plain text (.txt) file.

Exporting the Symbol List

Step	Action
1	<p>Either click the Export button or right-click anywhere in the list of symbols and choose Export symbols. You are prompted to save changes. The Export Symbols window is displayed.</p>
2	Browse and select the File path and File name of the Comma Separated Values (CSV) file to be created.
3	<p>Optionally, click Export options and configure formatting options for the exported values:</p> <p> <input type="checkbox"/> Export options Include <input checked="" type="checkbox"/> Headers <input checked="" type="checkbox"/> Comments Separator <input type="text" value="Semicolon"/> Codepage <input type="text" value="Unicode"/> </p>
4	<p>Click Export.</p> <p>Result: A CSV file is created with the specified formatting options.</p>

Sharing Symbols Between an EcoStruxure Machine Expert - Basic Project and an Vijeo-Designer Project

Before sharing the symbols with a Vijeo-Designer project, verify that all symbols that you want to share are defined in the EcoStruxure Machine Expert - Basic project. If not, create/open a project in EcoStruxure Machine Expert - Basic, define the symbol names, and save the project. You can create default Vijeo-Designer symbols for all memory objects in the project, refer to [Creating Default Symbols \(see page 160\)](#).

Follow these steps to share EcoStruxure Machine Expert - Basic symbols with a Vijeo-Designer project:

Step	Action
1	Start Vijeo-Designer.
2	Create/open a project in Vijeo-Designer.
3	Click the Project tab in the Navigator window, right-click IO Manager and select New Driver... Insert . Result: The New Driver window opens.
4	Select a driver from the Driver list, select an equipment from the Equipment list, and click OK . For example: <ul style="list-style-type: none"> ● Driver: Modbus TCP/IP ● Equipment: Modbus Equipment Result: The Equipment Configuration window opens.
5	Enter the details for each parameter and click OK . For example, IP Address , Unit ID , IP Protocol , and so on. Result: A new driver is created to open the communication with the controller. The selected driver and the selected equipment appear under the IO Manager node in the Project tab of the Navigator window.
6	In the Vijeo-Designer menu bar, click Variable → Link Variables . Result: The Link Variable window opens.
7	Select the Files of type filter to Ecostruxure Machine Expert - Basic project files (*.SMBP) and select the Equipment filter to the driver that you have created for communication.
8	Select the EcoStruxure Machine Expert - Basic project in which you have defined the symbols and click Open . Result: All the symbols are automatically extracted from the project and linked to the driver that you have created.
9	Select the variables that you want to use and add them to your HMI application. Result: All the variables with same names as symbols are added in the list of available variables. The variable list appears under the Variables node in the Project tab of the Navigator window.

NOTE: If you have already shared the symbols with a Vijeo-Designer project before and if you change the existing symbols and/or add new symbols to your project in EcoStruxure Machine Expert - Basic, you must update the symbols in the Vijeo-Designer project.

To update the symbols in a Vijeo-Designer project, first define new symbols and/or modify the existing symbols, save the EcoStruxure Machine Expert - Basic project, and open the Vijeo-Designer project and follow these steps:

Step	Action
1	In the Project tab of the Navigator window, right-click Variables and select Update Link . Result: The equipment driver and the existing symbols are updated.
2	Right-click Variables again, select New Variables from Equipment and select the new variables that you have created in the EcoStruxure Machine Expert - Basic project. Result: The new variables from the EcoStruxure Machine Expert - Basic project are added in the list of variables. These variables appear under the Variables node in the Project tab of the Navigator window.

Memory Consumption View

Overview

You can display information about the controller memory used by the application, program, and associated user data.

Displaying the Memory Consumption View

The program must first compile with no errors detected to use this feature. Refer to the Messages window (*see page 137*) for the current program status.

To open the **Memory consumption view**, follow this procedure:

Step	Action
1	Select the Tools tab in the left-hand area of the Programming window.
2	Click Memory Consumption . The Memory Consumption window is displayed.

Description of the Memory Consumption View

NOTE: This view is available only if there is a valid compilation.

The following tables describe the fields of the **Memory consumption view**:

Field	Description
Last Compilation	<p>The date and time on which the program was last compiled.</p> <p>NOTE: This value is updated whenever:</p> <ul style="list-style-type: none"> ● the Compile button  on the toolbar is clicked ● a login to a controller is initiated ● a program upload is started ● a program modification is sent to the controller in online mode ● the simulator is launched

Program lines	
Field	Description
Used	The number of lines of code being used by the program.
Remaining	The maximum number of lines available for the program minus the number of lines being used.
NOTE: There is no direct link between the number of program lines used and the total number of lines of IL code in rungs in the Programming tab. For example, 2 lines of IL code could generate 6 program lines.	

Cache memory	
Field	Description
Periodic and Event tasks	The amount of cache memory occupied by periodic and event tasks, in bytes.
Reserved for system	The amount of cache memory reserved for system use, in bytes.
Memory remaining	The amount of cache memory available to the program, in bytes.

RAM memory	
Field	Description
Master task and subroutines	The amount of RAM memory occupied by the program master task and all subroutines, in bytes.
Configuration	The amount of RAM memory used to contain the hardware configuration of the logic controller and expansion modules, in bytes.
Memory objects	The amount of RAM memory occupied by memory objects (memory bits, memory words, and constant words) used by the application, in bytes.
Display	The size of the Remote Graphic Display application, in bytes. Zero if the logic controller does not support the Remote Graphic Display.
Memory remaining	The amount of RAM memory available to the program, in bytes.

Non program data	
Field	Description
Used	The amount of memory occupied by project properties, symbols, comments, and animation tables.
Remaining	The amount of memory available for non program data.

Section 5.12

Ladder Language Programming

What Is in This Section?



This section contains the following topics:

Topic	Page
Introduction to Ladder Diagrams	168
Programming Principles for Ladder Diagrams	170
Color Coding of Rungs	172
Ladder Diagram Graphic Elements	174
Comparison Blocks	181
Operation Blocks	182
Adding Comments	186
Programming Best Practices	187

Introduction to Ladder Diagrams

Introduction

Ladder Diagrams are similar to relay logic diagrams that represent relay control circuits. The main differences between the 2 are the following features of Ladder Diagram programming that are not found in relay logic diagrams:

- All inputs and binary logic bits are represented by contact symbols ().
- All outputs and binary logic bits are represented by coil symbols ().
- Numerical operations are included in the graphical Ladder instruction set.

Ladder Diagram Equivalents to Relay Circuits

The following illustration shows a simplified wiring diagram of a relay logic circuit:

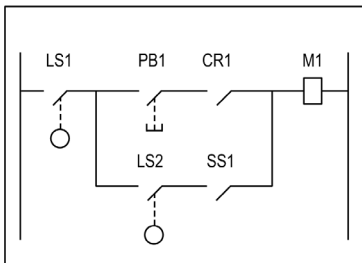

Relay logic circuit

The equivalent Ladder diagram:

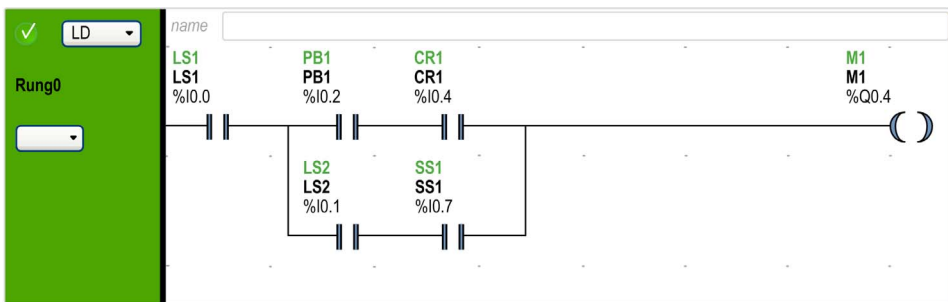

In the above illustration, all inputs associated with a switching device in the relay logic diagram are shown as contacts in the Ladder Diagram. The M1 output coil in the relay logic diagram is represented with an output coil symbol in the Ladder Diagram. The address numbers appearing above each input/contact/coil symbol in the Ladder Diagram are references to the locations of the external input/output connections to the logic controller.

Ladder Diagram Rungs

A program written in Ladder Diagram language is composed of rungs which are sets of graphical instructions drawn between 2 vertical potential bars. The rungs are executed sequentially by the logic controller.

The set of graphical instructions represents the following functions:

- Inputs/outputs of the controller (push buttons, sensors, relays, pilot lights, and so on)
- Functions of the controller (timers, counters, and so on)
- Math and logic operations (addition, division, AND, XOR, and so on)
- Comparison operators and other numerical operations ($A < B$, $A = B$, shift, rotate, and so on)
- Internal variables in the controller (bits, words, and so on)

These graphical instructions are arranged with vertical and horizontal connections leading eventually to one or several outputs and/or actions. A rung cannot support more than one group of linked instructions.

Example of Ladder Diagram Rungs

The following diagram is an example of a Ladder Diagram program composed of 2 rungs.

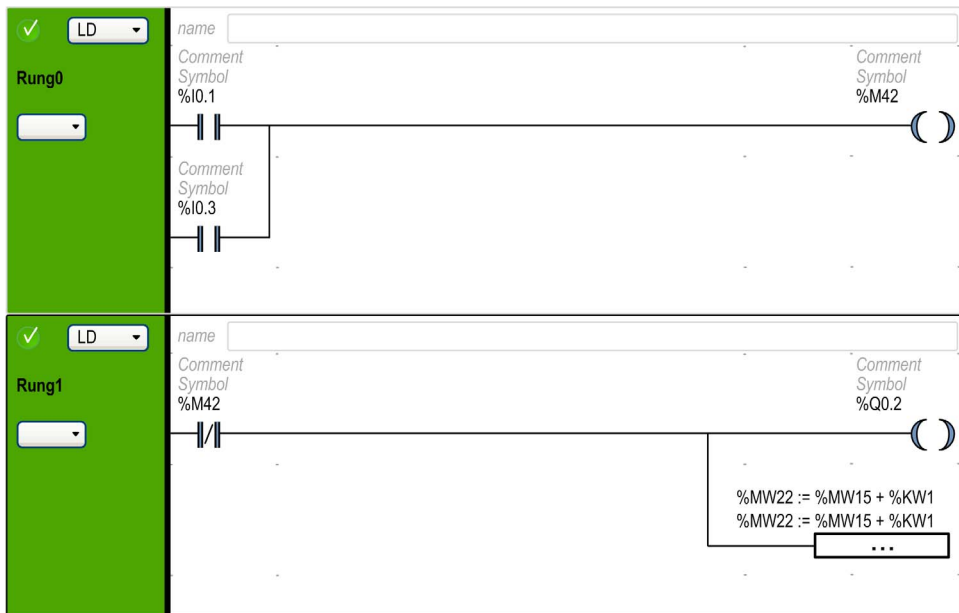

Programming Principles for Ladder Diagrams

Programming Grid

Each Ladder rung consists of a grid of up to 255 rows by 11...30 columns, organized into 2 zones as shown in the following illustration:

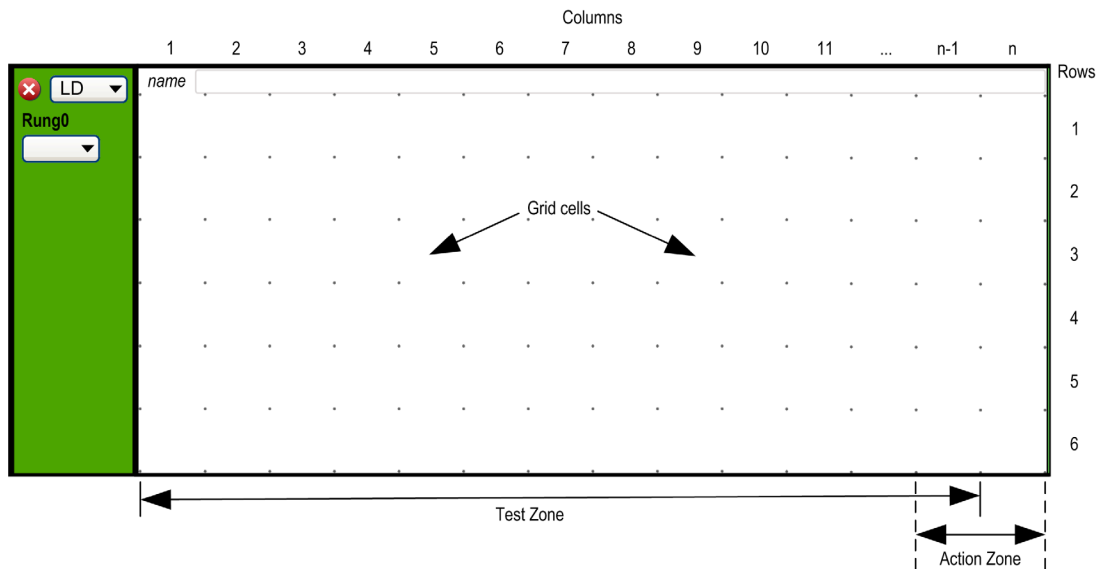

n Number of configured columns (11...30). For more information on configuration of number of columns, refer to Customizing the Ladder Editor ([see page 49](#)).

Grid Cells

Cells allow you to position graphical elements in the grid. Each cell in the grid is delimited by 4 dots at the corners of the cell.

Grid Zones

By default, the Ladder Diagram programming grid is divided into 2 zones:

- **Test zone**
Contains the conditions that are tested in order to perform actions. Consists of columns 1 to n-1, where n is the number of configured columns and contains contacts, function blocks, and comparison blocks.
- **Action zone**
Contains the output or operation that will be performed according to the results of the tests of the conditions in the Test zone. Consists of columns n-1 to n, where n is the number of configured columns and contains coils and operation blocks.

Customizing the Ladder Editor



Use the following objects at the top of the Ladder editor to customize the content of the editor:

Object	Description
IL>LD	Switch from displaying all rungs in IL to Ladder.
LD>IL	Switch from displaying all rungs in Ladder to IL.
-	Delete one column from the Ladder grid. The button is deactivated when the minimum number of columns (11) is reached.
+	Add one column to the Ladder grid. The button is deactivated when the maximum number of columns (30) is reached.
Display/hide comments	Click to display or hide comments in the rungs. If T is released, the comments display on two lines.
T	Click to display or hide the symbols in the rungs. If Display/hide comments is released, the symbols are displayed on two lines.
DEC/HEX	Only displayed in online mode. Click to display alternately numerical values in the rungs in decimal or hexadecimal format.
1 - New POU	Double-click to edit the default POU name that appears in the Tools → Master Task area of the screen.
Comment	Double-click to type text to associate a comment with this POU .
Zoom slider	Zoom or unzoom the Ladder Editor. You can zoom or unzoom by using the shortcut Ctrl + mouse wheel. The position of the zoom remains even if you navigate through the project.

Color Coding of Rungs

Offline Mode

The selected rungs are displayed in a darker green background:

× LD Rung0 <input style="width: 50px; height: 20px; background-color: white; border: 1px solid black;" type="text"/>	name Comment .
× LD Rung1 <input style="width: 50px; height: 20px; background-color: white; border: 1px solid black;" type="text"/>	name Comment .
× LD Rung2 <input style="width: 50px; height: 20px; background-color: white; border: 1px solid black;" type="text"/>	name Comment .

Online Mode

When in online mode:

- Unchanged rungs appear with a green background.
- Rungs added or modified while in online mode appear with an orange background:

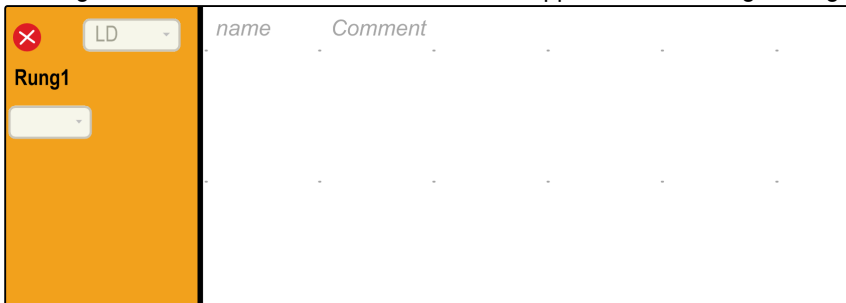

- Rungs with no modifiable elements are locked and appear with a gray foreground:

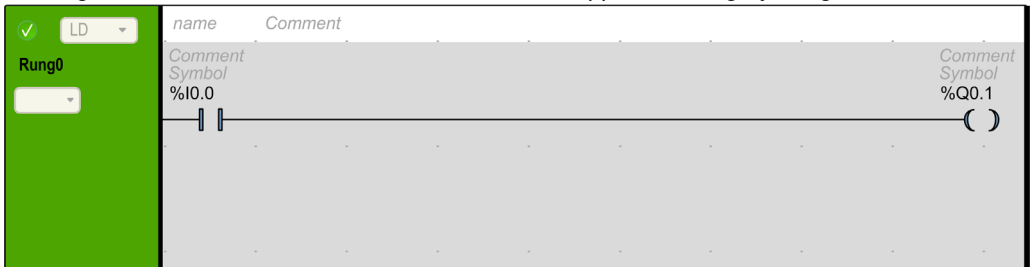

Ladder Diagram Graphic Elements

Introduction

Instructions in Ladder Diagrams are inserted by dragging and dropping graphic elements from the toolbar that appears above the programming workspace into a grid cell.



Inserting a Graphic Element

To insert a graphic element in a rung:

Step	Action
1	Click the graphic element on the toolbar to insert. If the graphic element is a menu, the graphic items in the menu appear; click the menu item to insert.
2	Move the mouse to the position in the rung to insert the graphic element and click. Note: Some elements have to be inserted in the test or action zones of the rung; refer to the description of individual graphic elements for details.
3	If necessary, click the [Selection mode] graphic element  on the toolbar to reset the selection.



Rungs

Use the following graphic elements to manage the rungs in a program:

Graphic Element	Name	Function
	Create a rung <i>(see page 90)</i>	Inserts a new empty rung below the last rung in the program workspace.
	Insert a rung <i>(see page 90)</i>	Inserts a new empty rung immediately above the currently selected rung.
	Delete the rung <i>(see page 92)</i>	Removes the currently selected rung from the program. If the rung is not empty, you are asked to confirm that you want to delete the contents of the rung.



Branching Modes

Use the following graphic elements to manage the branch in Ladder diagram:

Graphic Element	Name	Function
	Normal mode	Lets you place the programming elements (for example, contacts, coils, and so on, except the function blocks) inline with the wire line.
	Branching mode	Lets you place the programming elements (for example, contacts, coils, and so on, except the function blocks) in branch with the wire line.





Selections and Lines

Use the following graphic elements to select graphic elements and draw lines:

Graphic Element	Name	Function
	Selection mode	Selection mode.
	Draw line	Draws a wire line between 2 graphic elements.
	Erase line	Erases a wire line.

Contacts

Use the following graphic elements to insert contacts (one row high by one column wide).

Graphic Element	Name	Instruction List	Function
	Normally open contact	LD	Passing contact when the controlling bit object is at state 1.
	Normally closed contact	LDN	Passing contact when the controlling bit object is at state 0.
	Contact for detecting a rising edge	LDR	Rising edge: detecting the change from 0 to 1 of the controlling bit object.
	Contact for detecting a falling edge	LDF	Falling edge: detecting the change from 1 to 0 of the controlling bit object.

Comparison Block

Comparison blocks are placed in the test zone of the programming grid. The block may appear in any row or column in the test zone as long as the entire length of the instruction resides in the test zone.

The graphic element for comparison blocks takes up 2 cells (1 row high by 2 columns wide).

Graphic Element	Name	Instruction List	Function
	Comparison block	Any valid comparison expression	Use the Comparison block graphical symbol to insert Instruction List comparison expressions (<i>see page 181</i>) into Ladder Diagram rungs. A comparison expression compares 2 operands; the output changes to 1 when the result is checked.

Boolean Operations

The graphic element for boolean operations takes up 1 cell (1 row high by 1 column wide).

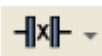
Graphic Element	Name	Operator	Function
	XOR instructions	XOR, XORN, XORR, XORF	The XOR instruction performs an exclusive OR operation between the operand and the Boolean result of the preceding instruction. The XORN instruction performs an exclusive OR operation between the inverse of the operand and the Boolean result of the preceding instruction. The XORR instruction performs an exclusive OR operation between the rising edge of the operand and the Boolean result of the preceding instruction. The XORF instruction performs an exclusive OR operation between the falling edge of the operand and the Boolean result of the preceding instruction.

Functions





Function blocks always appear in the first row of the Ladder Diagram programming grid; no Ladder instructions or lines of continuity may appear above or below the function block. Ladder test instructions lead to the left side of the function block, and test instructions and action instructions lead from the right side of the function.

The graphic elements of function blocks can only be placed in the test zone and require 2, 3, or 4 rows by 2 columns of cells.

Graphic Element	Name	Function
	Timers, counters, registers, and so on.	Each of the function blocks uses inputs and outputs that enable links to the other graphic elements. NOTE: Outputs of function blocks cannot be connected to each other (vertical shorts).



Coils

The coil graphic elements can only be placed in the action zone and take up 1 cell (1 row high and 1 column wide).

Graphic Element	Name	Operator	Function
	Direct coil	ST	The associated bit object takes the value of the test zone result.
	Inverse coil	STN	The associated bit object takes the negated value of the test zone result.
	Set coil	S	The associated bit object is set to 1 when the result of the test zone is 1.
	Reset coil	R	The associated bit object is set to 0 when the result of the test zone is 1.

Grafcet (List) Instructions

Use the following graphic elements to manage the branch in Ladder diagram:

Graphic Element	Name	Operator	Function
	Grafcet step activation/ Current step deactivation	#	Deactivates the current step and optionally activates another step in the Grafcet program.
	Grafcet step deactivation	#D	Deactivates a step in the Grafcet program in addition to deactivating the current step.

Operation Blocks

The operation block element placed in the action zone and occupy 2 columns by 1 row:



Graphic Element	Name	Operator	Function
	Operation block	Any valid operator or assignment instruction	Use the Operation block graphical symbol to insert Instruction List operations and assignment instructions (<i>see page 182</i>) into Ladder Diagram rungs.

Other Ladder Items









The **Other Ladder Items** menu  groups together miscellaneous instructions.

The **OPEN** and **SHORT** instructions provide a convenient method for debugging and troubleshooting Ladder programs. These special instructions alter the logic of a rung by either shorting or opening the continuity of a rung as explained in the following table.

The **END/JUMP** graphic elements are placed in the action zone and take up 1 cell (1 row high and 1 column wide).

Graphic Element	Name	Operator	Function
	Rising edge	RISING $n^{(1)}$	Evaluates the rising edge of the expression.
	Falling edge	FALLING $n^{(1)}$	Evaluates the falling edge of the expression.
	Logical NOT	N	Passes the inverse value of its operand.

⁽¹⁾ n is an integer incremented each time a rising or falling edge is inserted.

Graphic Element	Name	Operator	Function
	OPEN	LD 0 AND 0	At the beginning of the rung. Within a rung: Creates a break in the continuity of a Ladder rung regardless of the results of the last logical operation.
	SHORT	LD 1 OR 1	At the beginning of the rung. Within a rung: Allows the continuity to pass through the rung regardless of the results of the last logical operation.
	Stop program	END	Defines the end of the program.
	Conditional stop program	ENDCN	Defines a conditional end of the program.
	Jump or subroutine call	JMP	Connect to an upstream or downstream labeled rung. NOTE: When programming in IL, connection is to an upstream or downstream labeled instruction.
	Conditional jump or subroutine call	JMPCN	Conditional connect to an upstream or downstream labeled rung. NOTE: When programming in IL, connection is to an upstream or downstream labeled instruction.
	Conditional elements	IF ELSE ENDIF	Conditionally executes a group of statements, depending on the value of an expression.
	Loop elements	FOR ENDFOR	Repeats a group of statements.
(1) <i>n</i> is an integer incremented each time a rising or falling edge is inserted.			

Contacts and Coils

Once inserted in a cell, additional information is displayed about the object associated with contacts and coils:

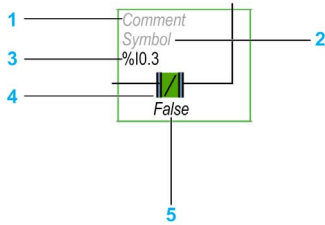

Legend	Item	Description
1	User comment	Click to add a comment (<i>see page 186</i>).
2	Symbol	Click to type the name of a symbol (<i>see page 68</i>) to associate with the object contained in the cell.
3	Address	Click to type the address of the object contained in the cell.
4	Graphic element	The graphic element.
5	Real-time value	When in online mode (connected to a logic controller and program running), displays the real-time value of the object in the cell.

Comparison Blocks

Inserting IL Comparison Expressions in Ladder Diagrams

You can use the **Comparison Block** graphical symbol to insert Instruction List comparison expressions into Ladder Diagram rungs:



The operands must be of the same object types: words with words, float with float, etc.

Proceed as follows:

Step	Action
1	Click the Comparison Block  button on the toolbar.
2	Click anywhere in the rung to insert the Comparison Block .
3	Double-click the Comparison expression line.
4	Type a valid Instruction List comparison operation and press ENTER. You can modify the expression in online mode. Refer to Online Modifications (see page 235).

NOTE:

If the application is configured with a functional level ([see page 80](#)) of at least **Level 6.0**:

- You can use up to five operands and three level of parentheses in a comparison block.
- A minimum of 20 memory words (%MW) must be available to use multiple operands in the master task. If using multiple operands in a periodic task as well, an additional 20 memory words must be available.

NOTE: Multiple operand expressions cannot be used in event tasks.

Getting Help with Syntax

If the syntax of the Instruction List comparison operation is incorrect, the border of the **Comparison expression** box turns red. For assistance, either:

- Move the mouse over the **Comparison expression** line, or
- Select **Tools** → **Program Messages**.

Operation Blocks

Inserting IL Operations and Assignment Instructions in Ladder Diagrams

You can use the **Operation Block** graphical symbol to insert Instruction List operations and assignment instructions into Ladder Diagram rungs:

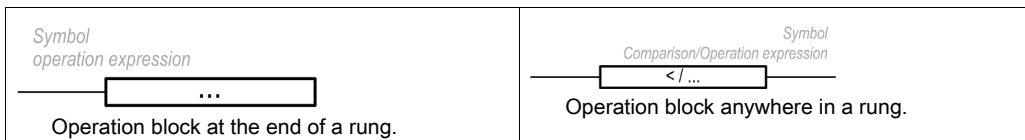

The **Operation Block** graphical symbol can be inserted in any position in a Ladder Diagram rung except the first column, as it cannot be used as the first contact in a rung.



If more than one **Operation Block** graphical symbol is used in a Ladder Diagram rung, they must be placed in series. **Operation Block** instructions cannot be used in parallel.

NOTE:

If the application is configured with a functional level (*see page 80*) of at least **Level 5.0**:

- You can use up to five operands and three levels of parentheses in a operation block. The operands must be of the same object types: words with words, float with float, etc.
- A minimum of 20 memory words (%MW) must be available to use multiple operands in the master task. If using multiple operands in a periodic task as well, an additional 20 memory words must be available.

To insert an operation block graphical symbol in a Ladder Diagram rung:

Step	Action
1	Click the Operation Block  button on the toolbar.
2	Click anywhere the rung to insert the Operation Block .
3	Click the Selection mode  button on the toolbar.
4	Double-click the operation expression line. The Smart Coding (<i>see page 183</i>) button  appears at the end of the line. Click this button for help selecting a function and with the syntax of the instruction.
5	Type a valid Instruction List operation or assignment instruction and press ENTER. For example: %MF10 := ((SIN(%MF12 + 60.0) + COS(%MF13)) + %MF10) + 1.2 You can modify the expression in online mode. Refer to Online Modifications (<i>see page 235</i>).

NOTE: Multiple operand expressions cannot be used in event tasks.

OPER Instruction Syntax

The `OPER` instruction corresponds to an operation block placed anywhere in a rung.

The equivalent `OPER` instruction can be used directly in Instruction List rungs.

`OPER [expression]` where *expression* is any valid expression, containing up to five operands and three levels of parentheses. For example:

```
OPER [ %MF10 := ((SIN( %MF12 + 60.0 ) + COS( %MF13 )) + %MF10 ) + 1.2]
```

Smart Coding Tooltips in Ladder Diagrams

To help you selecting functions, EcoStruxure Machine Expert - Basic displays tooltips while you type function names in operation blocks.

Two types of tooltip are available:

- A list of function names, dynamically updated with the function names that begin with the typed characters. For example, typing “AS” displays `ASCII_TO_FLOAT`, `ASCII_TO_INT`, and `ASIN`.
- Help with the syntax of a function, displayed when you type an opening parenthesis. For example, typing “ABS(“ displays:

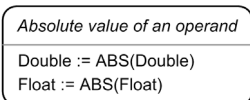

Using the Smart Coding Assistant

The Smart Coding Assistant appears when you click the Smart Coding button  in the operation expression line:

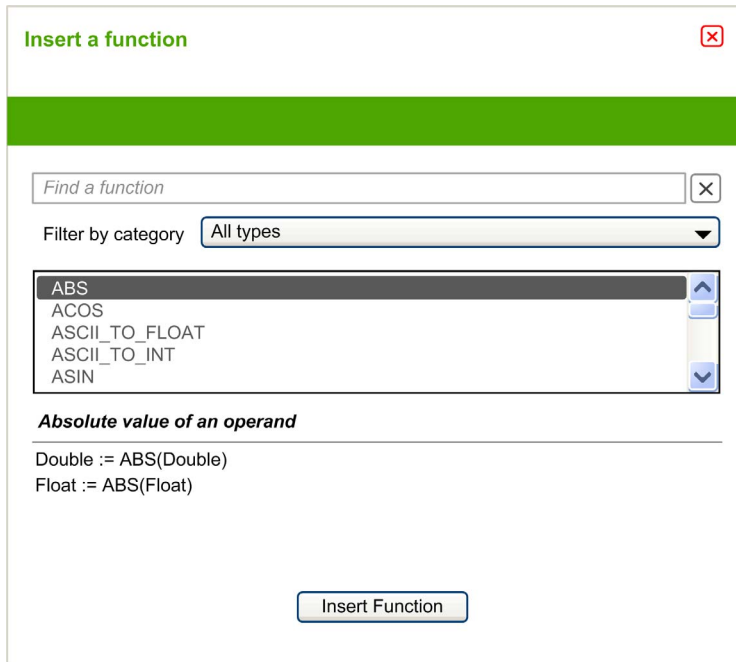

Proceed as follows:

Step	Action
1	Optionally, filter the list by category of function: <ul style="list-style-type: none"> ● All types ● ASCII ● Floating point ● I/O objects ● Floating Point ● Numerical Processing ● Table ● PID ● User-defined function
2	Select a function to add to the expression.
3	Click Insert Function .

Getting Help with Syntax

If the syntax of the Instruction List operation or assignment instruction is incorrect, the border of the **operation expression** box turns red. For assistance, either:

- Move the mouse over the **operation expression** line, or
- Select **Tools** → **Program Messages**.

Adding Comments

To Add Comments to Ladder Diagrams

To add comments to a Ladder Diagram program, follow these steps:

Step	Action
1	Insert a graphic element into the rung.
2	If necessary, click the selection pointer or press Esc.
3	Double-click the Comment line at the top of the graphic element.
4	Type the comment for the graphic element and press ENTER.

Example of Ladder Diagram Comments

This illustration shows an example of comments in a rung of a Ladder Diagram:

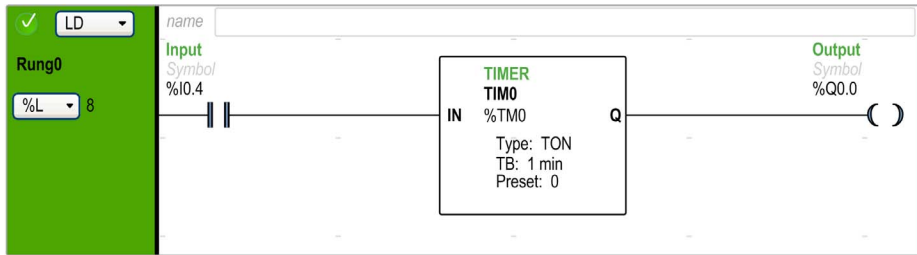

Programming Best Practices

Handling Program Jumps

Use program jumps with care to avoid long loops that can increase scan time. Avoid jumps to instructions that are located upstream.

NOTE: An upstream instruction line appears before a jump in a program. A downstream instruction line appears after a jump in a program.

Programming of Outputs

Physical outputs, as well as logical bits, should only be modified once in the program. In the case of physical outputs, only the last value scanned is taken into account when they are updated.

Using Directly-Wired Emergency Stop Sensors

Sensors used directly for emergency stops must not be processed by the logic controller. They must be connected directly to the corresponding outputs and applied in conformity with local, national and/or international regulations.

Handling Power Returns

After a power outage, make power returns conditional on a manual operation. An automatic restart of the installation could cause unintended operation of equipment (use system bits %S0, %S1, and %S49). Other system bits and system words may also help manage restarts after power outages. Refer to System Bits (%S) and System Words (%SW) (*see Modicon M221, Logic Controller, Programming Guide*).

WARNING

UNINTENDED EQUIPMENT OPERATION

Do not use the equipment configured and programmed by this software in safety-critical machine functions, unless the equipment and software are otherwise designated as functional safety equipment and conforming to applicable regulations and standards.

Failure to follow these instructions can result in death, serious injury, or equipment damage.

Time and Schedule Block Management

The state of system bit %S51, which indicates any detected RTC errors, should be verified.

Syntax Validation

As you are programming, EcoStruxure Machine Expert - Basic validates the syntax of the instructions, the operands, and their associations.

Additional Notes on Using Parentheses

Do not place assignment instructions within parentheses:

```
LD    %I0.0
MPS
AND  %I0.1
OR (  %I0.2
)
```

The equivalent Ladder Diagram produces a short circuit error:

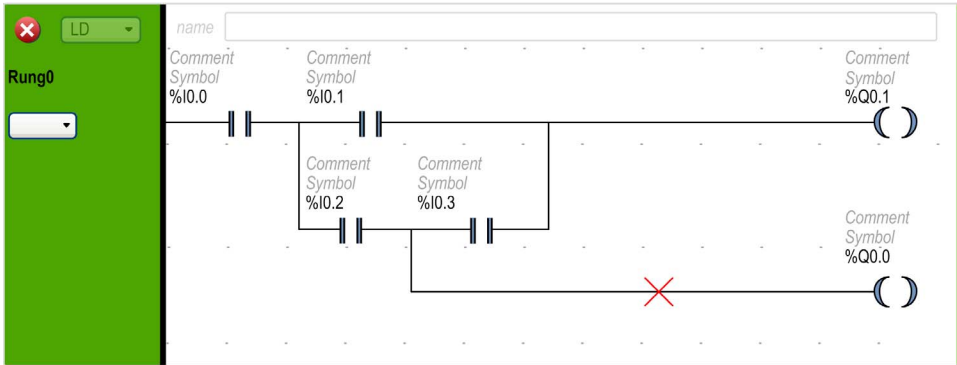

In order to perform the same function, program the instructions in the following manner:

```
LD    %I0.0
MPS
AND ( %I0.1
OR (  %I0.2
AND  %I0.3
)
)
ST   %Q0.1
MPP
AND  %I0.2
ST   %Q0.0
```

The equivalent Ladder Diagram:

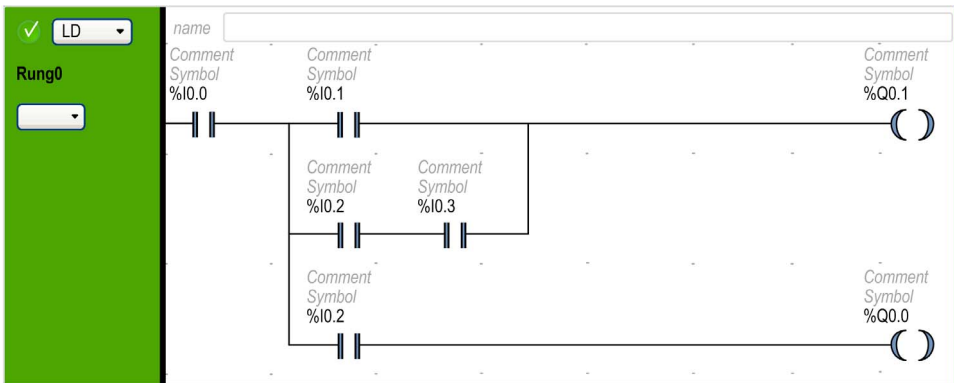

If several contacts are in parallel, nest them within each other:

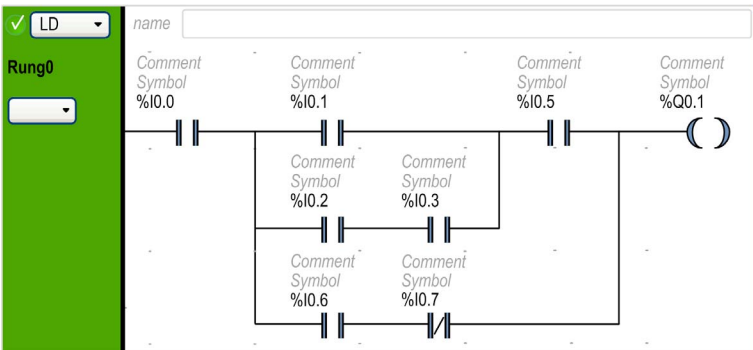

Alternatively, completely separate the contacts as follows:

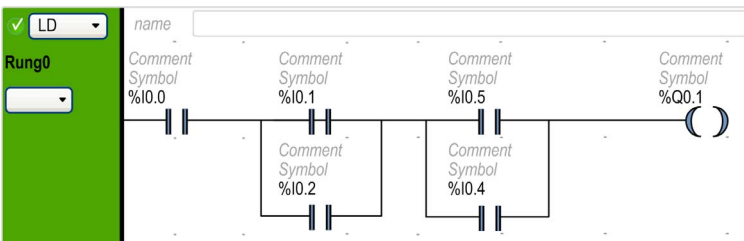

Section 5.13

Instruction List Programming

What Is in This Section?

This section contains the following topics:

Topic	Page
Overview of Instruction List Programs	191
Operation of List Instructions	194
List Language Instructions	195
Using Parentheses	199

Overview of Instruction List Programs

Introduction

A program written in Instruction List language consists of a series of instructions that are executed sequentially by the logic controller. Each instruction is represented by a single program line and consists of the following components:

- Line number
- Current value (in online mode only)
- Instruction operator
- Operand(s)
- Optional comment

Example of an Instruction List Program

The following is an example of an Instruction List program.

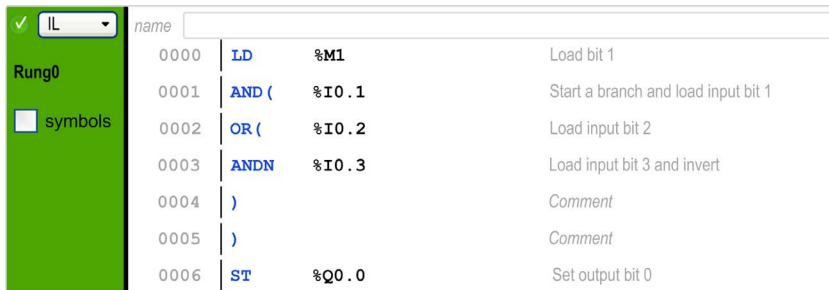

Line Number	Instruction	Operand(s)	Comment
0000	LD	%M1	Load bit 1
0001	AND (%I0.1	Start a branch and load input bit 1
0002	OR (%I0.2	Load input bit 2
0003	ANDN	%I0.3	Load input bit 3 and invert
0004)		Comment
0005)		Comment
0006	ST	%Q0.0	Set output bit 0

Line Numbers

Four-digit line numbers are generated when you create a new program line and managed automatically by EcoStruxure Machine Expert - Basic.

Current Values

When EcoStruxure Machine Expert - Basic is in online mode (*see page 31*) (connected to a logic controller and the program is running), EcoStruxure Machine Expert - Basic displays the current value of object types in the IL editor window.

The displayed values of these objects are updated.

Instruction Operators

The instruction operator is a mnemonic symbol, called an operator, that identifies the operation to be performed using the operands. Typical operators specify Boolean and numerical operations.

For example, in the sample program above, `LD` is the mnemonic for the `LOAD` operator. The `LOAD` instruction places (loads) the value of the operand `%M1` into an internal register called the boolean accumulator.

There are basically 2 types of operators:

- Test operators
These set up or test for the conditions necessary to perform an action. For example, `LOAD (LD)` and `AND`.
- Action operators
These perform actions as a result of preceding logic. For example, assignment operators such as `STORE (ST)` and `RESET (R)`.

Operators, together with operands, form instructions.

Operands

An operand is an object, address, or symbol representing a value that a program can manipulate in an instruction. For example, in the sample program above, the operand `%M1` is an address assigned the value of an embedded input of the logic controller. An instruction can have from 0 to 3 operands depending on the type of instruction operator.

Operands can represent the following:

- Controller inputs and outputs such as sensors, push buttons, and relays.
- Predefined system functions such as timers and counters.
- Arithmetic, logical, comparison, and numerical operations.
- Controller internal variables such as system bits and words.

Comments

To add comments to an Instruction List program

Step	Action
1	Optionally, click the comment box that appears at the top of the rung above the first line 0000 and type a comment for the rung.
2	Insert an instruction line.
3	Click in the Comment area to the right of the instruction.
4	Type the comment and press <code>Enter</code> .

Customizing the Ladder/IL Editor



Use the following objects at the top of the IL editor to customize the content of the editor:

Object	Description
IL>LD	Switch from displaying all rungs in IL to Ladder.
LD>IL	Switch from displaying all rungs in Ladder to IL.
-	Delete one column from IL grid. The button is deactivated when the minimum number of columns (11) is reached.
+	Add one column to IL grid. The button is deactivated when the maximum number of columns (30) is reached.
Display/Hide comments	Click to display or hide comments in the rungs.
T	Click to alternately display objects in address mode or symbol mode.
DEC/HEX	Only active in online mode. Click to alternately display numerical values in the rungs in decimal or hexadecimal format.
1 - New POU	Double-click to edit the default POU name that appears in the Tools → Master Task area of the screen.
Comment	Double-click to type text to associate a comment with this POU .
Zoom slider	Zoom or unzoom the Ladder Editor. You can zoom or unzoom by using the shortcut Ctrl + mouse wheel . The position of the zoom remains even if you navigate through the project.

Operation of List Instructions

Introduction

Instruction List binary instructions normally have only one explicit operand; the other operand is implied. The implied operand is the value in the Boolean accumulator. For example, in the instruction `LD %I0.1, %I0.1` `%I0.1` is the explicit operand. An implicit operand is loaded in the accumulator and the previous value of the accumulator is overwritten by the value of `%I0.1`. This value now becomes the implicit value for the subsequent instruction.

Operation

An Instruction List instruction performs a specified operation on the contents of the accumulator and the explicit operand, and replaces the contents of the accumulator with the result. For example, the operation `AND %I1.2` performs a logical AND between the contents of the accumulator and the input `1.2` and will replace the contents of the accumulator with this result.

All Boolean instructions, except for `Load`, `Store`, and `Not`, operate on 2 operands. The value of the 2 operands can be either `True` or `False`, and program execution of the instructions produces a single value: either `True` or `False`. `Load` instructions place the value of the operand in the accumulator while `Store` instructions transfer the value in the accumulator to the operand. The `Not` instruction has no explicit operands and simply inverts the state of the accumulator.

Supported List Instructions

This table shows a selection of instructions in Instruction List language:

Type of Instruction	Example	Function
Boolean instruction	<code>LD %M10</code>	Loads the value of internal bit <code>%M10</code> into the accumulator
Block instruction	<code>IN %TM0</code>	Starts the timer <code>%TM0</code>
Word instruction	<code>[%MW10 := %MW50+100]</code>	Addition operation
Program instruction	<code>SR5</code>	Calls subroutine #5

List Language Instructions

Introduction







The Instruction List language consists of the following types of instructions or block of instructions:



- Test Instructions
- Action instructions
- Function blocks

This section identifies and describes the instructions for List programming.

Test Instructions

This table describes test instructions in List language.

Mnemonic	Name	Equivalent Graphic Element	Function
LD	Load		Loads the boolean value of the operand into the accumulator.
LDN	Load Not		Loads the negated boolean value of the operand into the accumulator.
LDR	Load Rising		Loads the boolean value of the operand into the accumulator when the value changes from 0 to 1 (rising edge). The value of the accumulator thereafter will be loaded with 0 until the next transition of the operand from 0 to 1.
LDF	Load Falling		Loads the boolean value of the operand into the accumulator when the value changes from 1 to 0 (falling edge). The value of the accumulator thereafter will be loaded with 1 until the next transition of the operand from 1 to 0.
AND	And		The Boolean result is equal to the AND logic between the Boolean result of the previous instruction (which is stored in the accumulator) and the status of the operand. The result of the instruction is then itself implicitly loaded into the accumulator overwriting the previous value.
ANDN	And Not		The Boolean result is equal to the AND logic between the Boolean result of the previous instruction (which is stored in the accumulator) and the inverse (negated) status of the operand. The result of the instruction is then itself implicitly loaded into the accumulator overwriting the previous value.

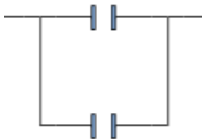
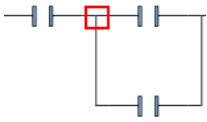
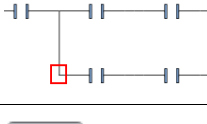
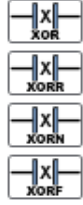
Mnemonic	Name	Equivalent Graphic Element	Function
ANDR	And Rising		The Boolean result is equal to the AND logic between the Boolean result of the previous instruction and the detection of the operand's rising edge (1 = rising edge). The result of the instruction is then itself implicitly loaded into the accumulator overwriting the previous value.
ANDF	And Falling		The Boolean result is equal to the AND logic between the Boolean result of the previous instruction and the detection of the operand's falling edge (1 = falling edge). The result of the instruction is then itself implicitly loaded into the accumulator overwriting the previous value.
OR	Or		The Boolean result is equal to the OR logic between the Boolean result of the previous instruction and the status of the operand (which is stored in the accumulator).
AND(And With		Logic AND (Maximum 32 levels of parentheses). The parentheses specify an intermediate logical result of the instructions between them, and then that result is logically AND'd with the value in the accumulator.
OR(Or With		Logic OR (Maximum 32 levels of parentheses). The parentheses specify an intermediate logical result of the instructions between them, and then that result is logically OR'd with the value in the accumulator.
XOR XORN XORR XORF	Ex Or Ex Or Not Ex Or Rising Ex Or Falling		Exclusive OR

Mnemonic	Name	Equivalent Graphic Element	Function
MPS MRD MPP	Memory Push Store Memory ReaD Memory PoP		Branch operators for output actions.
N	Not		Inverts the value of the operand.

Action Instructions

This table describes action instructions in List language.

Mnemonic	Name	Equivalent Graphic Element	Function
ST	Store		The associated operand takes the value of the test zone result.
STN	Store Not		The associated operand takes the reverse value of the test zone result.
S	Set		The associated operand is set to 1 when the result of the test zone is 1.
R	Reset		The associated operand is set to 0 when the result of the test zone is 1.
JMP	Jump		Connect unconditionally to a labeled sequence, upstream, or downstream.
SRn	Subroutine		Connection at the beginning of a subroutine (subroutine call).
END	End		End of program.
ENDCN	End Conditional		Conditionally ends the program at a Boolean result of 0.

Function Blocks

This table describes function blocks in List language.

Name	Equivalent Graphic Element	Function
Timers, counters, registers, and so on.		<p>For each of the function blocks, there are instructions for controlling the block.</p> <p>A structured form is used to connect the block inputs and outputs.</p> <p>Note: Outputs of function blocks cannot be connected to each other (vertical shorts).</p> <p>For more information, refer to Software Objects <i>(see EcoStruxure Machine Expert - Basic, Generic Functions Library Guide).</i></p>

Using Parentheses

Introduction

With `AND` and `OR` logical operators, parentheses are used to nest logical instructions. In so doing, they specify divergences (branches) in the Ladder editor. Parentheses are associated with instructions as follows:

- Opening the parentheses is associated with the `AND` or `OR` operator.
- Closing the parentheses is an instruction (an operator with no operand) which is required for each open parenthesis.

Example Using an `AND` Instruction

The following examples show how to use parentheses with an `AND` instruction:

Rung	Instruction
0	LD %I0.0 AND %I0.1 OR %I0.2 ST %Q0.0
1	LD %I0.0 AND (%I0.1 OR %I0.2) ST %Q0.1

NOTE: Refer to the reversibility procedure (*see EcoStruxure Machine Expert - Basic, Generic Functions Library Guide*) to obtain the equivalent Ladder Diagram.

Example Using an `OR` Instruction

The following example shows how to use parentheses with an `OR` instruction:

Rung	Instruction
0	LD %I0.0 AND %I0.1 OR (%I0.2 AND %I0.3) ST %Q0.0

NOTE: Refer to the reversibility procedure (*see EcoStruxure Machine Expert - Basic, Generic Functions Library Guide*) to obtain the equivalent Ladder Diagram.

Modifiers

This table lists modifiers that can be assigned to parentheses.

Modifier	Function	Example
N	Negation	AND(N or OR(N
F	Falling edge	AND(F or OR(F
R	Rising edge	AND(R or OR(R
[Comparison	See Comparison Instructions.

NOTE: The '[' modifier can also be used in conjunction with other instructions serving as an operator. For more uses of the '[' in other instructions, refer to the Introduction to Numerical Operations.

Nesting Parenthesis

It is possible to nest up to 32 levels of parentheses.

Observe the following rules when nesting parentheses:

- Each open parenthesis must have a corresponding closed parenthesis.
- Labels (`%Li :`), subroutines (`SRi :`), `JMP` instructions (`JMP`), and function block instructions must not be placed in expressions between parentheses.
- Store instructions (`ST`, `STN`, `S`, and `R`) must not be programmed between parentheses.
- Stack instructions (`MPS`, `MRD`, and `MPP`) cannot be used between parentheses.

Examples of Nesting Parentheses

The following examples show how to nest parentheses:

Rung	Instruction
0	<pre>LD %I0.0 AND (%I0.1 OR (N %I0.2 AND %M3)) ST %Q0.0</pre>
1	<pre>LD %I0.1 AND (%I0.2 OR (%I0.5 AND %I0.6) AND %I0.4 OR (%I0.7 AND %I0.8)) ST %Q0.0</pre>

NOTE: Refer to the reversibility procedure (*see EcoStruxure Machine Expert - Basic, Generic Functions Library Guide*) to obtain the equivalent Ladder Diagram.

Section 5.14

Grafcet (List) Programming

What Is in This Section?

This section contains the following topics:

Topic	Page
Description of Grafcet (List) Programming	203
Grafcet (List) Program Structure	204
How to Use Grafcet (List) Instructions in an EcoStruxure Machine Expert - Basic Program	208

Description of Grafcet (List) Programming









Introduction

Grafcet (List) programming in EcoStruxure Machine Expert - Basic offer a simple method of translating a control sequence in to steps. You can translate control sequences in to Grafcet steps and then use these steps in a program using Grafcet instructions.

The maximum number of Grafcet steps depend on the controller. The number of steps active at any one time is limited only by the total number of steps.

Grafcet Instructions

An EcoStruxure Machine Expert - Basic Grafcet program has the following instructions:

Operator	Operand	IL Instruction	Instruction Name	Graphic Equivalent	Description
=*=	x	=*= x	INITIAL STEP		This instruction defines the initial step in the program.
=*= POST	Not applicable	=*= POST	POST PROCESSING (implicit operand)		This instruction defines the post-processing and end sequential processing.
-*-	x	-*- x	STEP		This instruction defines a step in the program for transition validation.
#	Not applicable	#	DEACTIVATE CURRENT STEP (implicit operand)		This instruction deactivates the current step in the program.
#	x	#x	DEACTIVATE CURRENT STEP and ACTIVATE STEP x		This instruction deactivates the current step and activates step x in the program.
#D	x	#D x	DEACTIVATE CURRENT STEP and STEP x		This instruction deactivates the current step and step x in the program.
S	x	S x	ACTIVATE STEP x		This instruction activates step x in the program. The action has no affect on any other active steps.
R	x	R x	DEACTIVATE STEP x		This instruction deactivates step x in the program. The action has no affect on any other active steps.

x Grafcet step number (an integer starting from 1).

Grafcet (List) Program Structure

Introduction

An EcoStruxure Machine Expert - Basic Grafcet (List) program has the following parts:

- Preprocessing
- Sequential processing
- Post-Processing

Preprocessing

Preprocessing consists of the following:

- Power returns
- Error management
- Changes of operating mode
- Pre-positioning Grafcet steps
- Input logic

In this example, the system bit %S21 is set to 1 with the rising edge of input %I0.6 (Rung1). This disables the active steps and enables the initial steps:

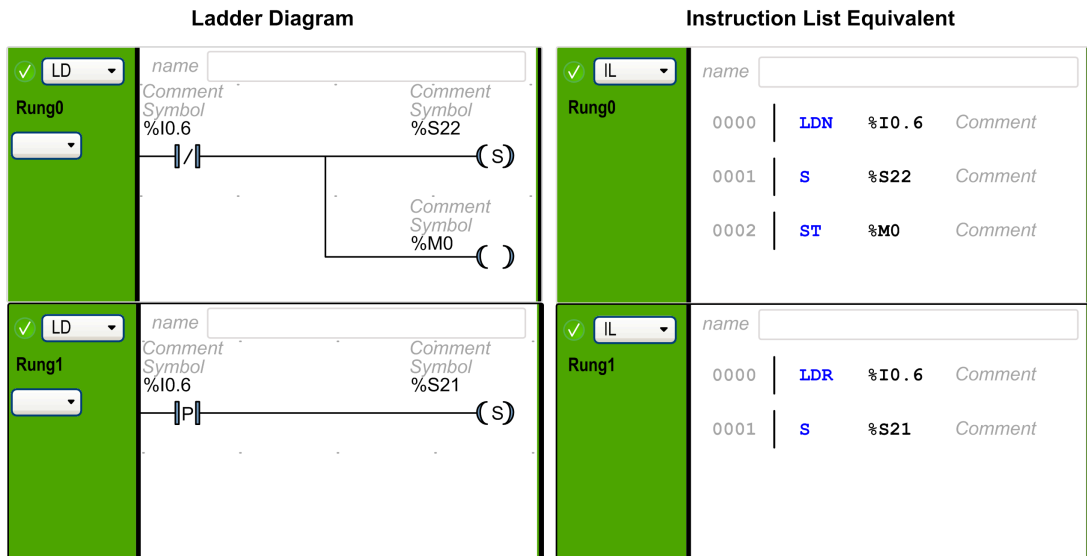

Preprocessing begins with the first line of the program and ends with the first occurrence of a **==*** or **-*** instruction.

System bits %S21, %S22, and %S23 are dedicated to Grafcet control. Each of these system bits is set to 1 (if needed) by the application, normally in preprocessing. The associated function is performed by the system at the end of preprocessing and the system bit is then reset to 0 by the system.

System Bit	Name	Description
%S21	Grafcet initialization	All active steps are deactivated and the initial steps are activated.
%S22	Grafcet re-initialization	All steps are deactivated.
%S23	Grafcet pre-positioning	This bit must be set to 1 if %Xi objects are explicitly written by the application in preprocessing. If this bit is maintained to 1 by the preprocessing without any explicit change of the %Xi objects, Grafcet is frozen (no updates are taken into account).

Sequential Processing

Sequential processing takes place in the chart (instructions representing the chart):

- Steps
- Actions associated with steps
- Transitions
- Transition conditions

Example:

Ladder Diagram

✓ LD		<i>name</i> <input type="text"/>			
Rung0	=*=	1	<i>Comment</i> Symbol %I0.2	<i>Comment</i> Symbol %I0.3	<i>Comment</i> Symbol %X2
✓ LD		<i>name</i> <input type="text"/>			
Rung1			<i>Comment</i> Symbol %I0.3	<i>Comment</i> Symbol %I0.2	<i>Comment</i> Symbol %X3
✓ LD		<i>name</i> <input type="text"/>			
Rung2	-*-	2	<i>Comment</i> Symbol %I0.4	<i>Comment</i> Symbol %X1	
✓ LD		<i>name</i> <input type="text"/>			
Rung3	-*-	3	<i>Comment</i> Symbol %I0.5	<i>Comment</i> Symbol %X1	

Instruction List Equivalent

✓ IL		<i>name</i> <input type="text"/>			
Rung0			0000	=*=	1
<input type="checkbox"/> Symbols					
			0001	LD	%I0.2
			0002	ANDN	%I0.3
			0003	#	2
✓ IL		<i>name</i> <input type="text"/>			
Rung1			0000	LD	%I0.3
<input type="checkbox"/> Symbols					
			0001	ANDN	%I0.2
			0002	#	3
✓ IL		<i>name</i> <input type="text"/>			
Rung2			0000	-*-	2
<input type="checkbox"/> Symbols					
			0001	LD	%I0.4
			0002	#	1
✓ IL		<i>name</i> <input type="text"/>			
Rung3			0000	-*-	3
<input type="checkbox"/> Symbols					
			0001	LD	%I0.5
			0002	#	1

Sequential processing ends with the execution of the **POST** instruction or with the end of the program.

Post-Processing

Post-processing consists of the following:

- Commands from the sequential processing for controlling the outputs
- Interlocks specific to the outputs

Example:

Ladder Diagram

The ladder diagram consists of three rungs. Rung 0 starts with a normally closed contact labeled '%I0.2', followed by a normally open contact labeled '%I0.3', and ends with a coil labeled '%X2'. Rung 1 starts with a normally open contact labeled '%I0.4' and ends with a coil labeled '%Q0.2'. Rung 2 starts with a normally open contact labeled '%X1' and ends with a coil labeled '%Q0.1'.

Instruction List Equivalent

Address	Instruction	Symbol	Comment
0000	==	1	Comment
0001	LD	%I0.2	Comment
0002	ANDN	%I0.3	Comment
0003	#	2	Comment
0000	-*-	2	Comment
0001	LD	%I0.4	Comment
0002	ST	%Q0.2	Comment
0000	==	POST	Comment
0001	LD	%X1	Comment
0002	ST	%Q0.1	Comment

How to Use Grafcet (List) Instructions in an EcoStruxure Machine Expert - Basic Program

NOTE: Grafcet (List) instructions can only be used in the master task of a program.

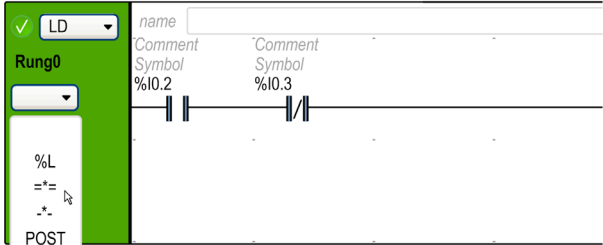

Creating Grafcet (List) Steps in Ladder

Follow these steps to create Grafcet steps in a program:

Step	Action
1	<p>In a POU, select a rung and click the drop-down button below the rung sequence identifier Rungx, where x is the rung number in a POU.</p>  <p>Result: A menu appears listing the available Grafcet (List) instructions.</p>
2	<p>Click an instruction in the list to define the rung as an initial step, post processing, or a step of the Grafcet (List) program.</p> <p>Result: The rung is set for a Grafcet instruction. The operator of the instruction appears on the button and the operand (step number) appears in suffix with the button.</p> <p>NOTE: The step number is incremented by 1 as you define the next STEP or INITIAL STEP instruction. You can define only one POST instruction in a program; therefore the POST instruction does not have any step number.</p> <p>To modify the step number, double-click the step number in a rung and enter the new number and then press ENTER.</p>

Activating or Deactivating Grafcet (List) Steps in Ladder

Follow these steps to activate or deactivate Grafcet (List) steps in a program:

Step	Action
1	In a POU, select a rung in your program.
2	 (to deactivate the current step and optionally activate a specified step) or  (to deactivate the current step and to deactivate the specified step) and insert this element in the action zone of the rung (refer to Inserting a Graphic Element (see page 174)).
3	<p>Alternatively, Press ALT+A to use ACTIVATE instruction or press ALT+D to use DEACTIVATE instruction in the rung.</p> <p>Result: The activate or deactivate ladder symbol appears in the action zone of the rung. Press ENTER to insert this element.</p>
4	<p>In the program rung, double-click Address field on the Grafcet activate or deactivate symbol and enter the Grafcet bit address (%Xi, where i is the step number).</p> <p>For example, %X4 refers to the step 4 of the Grafcet program. If %X4 is the address for the deactivate symbol, step 4 will be deactivated when the output of the rung, in which this symbol is used, is true.</p> <p>NOTE: Current step is deactivated in every case.</p>

Section 5.15

Grafcet (SFC) Programming

What Is in This Section?

This section contains the following topics:

Topic	Page
Introduction to Grafcet (SFC) Programming	211
Using the Grafcet (SFC) Graphical Editor	214
Branching	219
Programming Best Practices	223

Introduction to Grafcet (SFC) Programming

Introduction

Grafcet (SFC) is a graphical programming language that describes a chronological order of execution of discrete tasks, known as *steps*. The order in which steps are executed is determined by *transitions* connecting the steps.

Elements of a Grafcet (SFC) POU

A Grafcet (SFC) POU has the following components:

- **Step:** A step executes a set of actions defined in one of more rungs written in the Ladder/IL programming languages. Steps can be:
 - **Initial step:** Executed at the beginning of the program or following a controller restart. It is represented by a cell with a double border.
 - **Regular step:** Steps conditionally executed after the initial step completes execution.
- **Transition:** A boolean expression evaluated between steps. It is the link between two or more steps. The boolean expression is defined in a single transition rung written in the Ladder/IL programming languages.

The following diagram is an example of a Grafcet (SFC) POU with an initial step, one regular step, and two transitions:

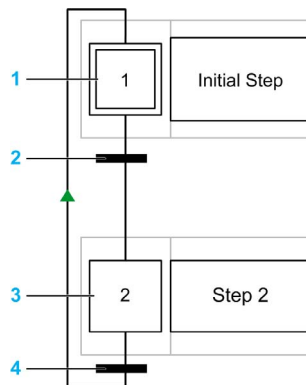

- 1 Initial step
- 2 Transition from step 1 to step 2
- 3 Regular step
- 4 Transition from step 2 back to step 1. An arrow is displayed on the link to indicate that the order of step execution is not the default left to right, top to bottom.

Grafcet (SFC) POU Rules

Grafcet POU can only be created in the master task of a program.

Multiple Grafcet POUs can be created.

Grafcet (SFC) Processing

The following rules are applied by the logic controller when executing the Grafcet (SFC):

- The master task cycle starts.
- The POUs that precede the first Grafcet (SFC) step are executed in a sequential way.
- The first Grafcet (SFC) step launches the **Grafcet monitor**.
- When the **Grafcet monitor** ends, the first POU that follows the last Grafcet (SFC) step is called.

Grafcet monitor behavior:

1. The logic controller processes the associated Grafcet (SFC) system bits %S21, %S22, and %S23.
2. The logic controller updates the activation states of each Grafcet (SFC) step.
 - Steps marked to be deactivated are deactivated.
 - Steps marked to be activated are activated.
 - Steps marked to be activated and deactivated at the same time will be or will remain activated.
 - Activation and deactivation lists are reset.
3. The logic controller scans the steps (loop from lowest defined step number to highest defined step number). When a scanned step is activated, the associated step code is called.
4. When a transition code activates or deactivates a step, this action is placed respectively in the activation or deactivation list for the next task cycle.
5. When the last active step code is executed, the **Grafcet monitor** ends.

Multi-Token Behavior

EcoStruxure Machine Expert - Basic Grafcet POU is multi-token which does not conform to IEC 61131-3.

The initial situation is controlled by the steps defined as initial steps.

Multiple steps can be active at the same time in a Grafcet POU.

The active signal status processes take place along the directional links, triggered by switching one or more transitions. The direction of the process follows the directional links and runs from the underside of the predecessor step to the top side of the successive step.

A transition is evaluated if the steps immediately preceding it are active. Transitions are not evaluated if the steps immediately preceding them are not active.

A transition is triggered when the associated transition conditions are satisfied.

Triggering a transition marks as deactivated the immediately preceding steps that are linked to the transition, and marks as activated the immediately following steps.

The real activation or deactivation of the steps is performed at the beginning of each master task cycle (see **Grafcet monitor** (*see page 212*)).

If more than one transition condition in a row of sequential steps has been satisfied, then one step is processed per cycle.

If a step is activated and deactivated at the same time, then the step will be or will remain activated.

More than one branch can be active with alternative branches.

The branches to be run are determined by the result of the transition conditions of the transitions that follow the alternative branch. Branch transitions are processed in parallel.

The branches with satisfied transitions are triggered.

Subroutine calls can be used in step actions.

Bits Controlling Grafcet (SFC)

Control bit	Name	Description
%S21	Grafcet initialization	If set to 1, the initial steps in the Grafcet POU are evaluated.
%S22	Grafcet reset	If set to 1, the steps are deactivated and execution restarts.
%S23	Preset and freeze Grafcet	If set to 1, execution of the Grafcet POU stops until the bit is set to 0.
%Xi	Grafcet steps	Bits %X1 to %Xi are associated with Grafcet steps. Step bit %Xi is set to 1 when the corresponding step is active, and set to 0 when the step is deactivated. The bit is not writable when using Grafcet (SFC).

Refer to the description of System Bits (*see Modicon M221, Logic Controller, Programming Guide*) for further details.

Using the Grafcet (SFC) Graphical Editor

Overview

The Grafcet Graphical Editor is used for programming in Grafcet (SFC).

To display the Grafcet Graphical Editor, select any n - **Grafcet** node in the tree view.

The Grafcet Graphical Editor contains a grid of cells. Each cell contains one step, one transition, or both.

The minimum size of a Grafcet POU is one step.

The maximum number of Grafcet Step objects that the application can contain is:

- 96, if the **Functional Level** < 10.0
- 200, if the **Functional Level** >= 10.0

Detaching the Grafcet Graphical Editor

You can detach the Grafcet Graphical Editor window from the main EcoStruxure Machine Expert - Basic window so that it can be moved and resized independently. This allows you, for example, to move it to a separate monitor and display Grafcet POUs at the same time as IL/Ladder POUs.

To detach the window, click the  button in the top right corner of the Grafcet Graphical Editor window.

Drag the title bar of the window to move it. Close the window to revert to the normal view.

Inserting Steps

Double-click in any grid cell to add a step, or right-click in any grid cell and choose **Add a step** from the contextual menu that appears.

You can see the **Number of Grafcet steps used** in the top right corner of the Grafcet Graphical Editor window.

You can move a step by dragging and dropping in another grid cell.

Changing a Step Type (Initial or Regular)

The first step created in the Grafcet Graphical Editor is by default an initial step.

A Grafcet POU must contain at least one initial step. More than one step can be defined as initial steps.

To change the step type (initial/regular), right-click the step and choose **Set/Unset as initial step**.

Copying and Pasting a Step

Step	Action
1	Right-click on the step to copy and choose Copy from the contextual menu that appears.
2	Right-click in an empty grid cell and choose Paste . Result: A copy of the step appears. Copies of Ladder/IL rungs associated with the step are added below the corresponding Step subnode in the tree view.

Creating Transitions

Link steps together to define the order of execution of steps.

To create a transition between two steps:

Step	Action
1	Move the mouse over the bottom of a step. Result: A green block appears
2	Drag the mouse to the step you want to link to.
3	Release the mouse button. Result: A link and transition appear.

Editing Labels

To edit the default labels of any step or transition.

Step	Action
1	Double-click the label of any Grafcet (SFC) step or transition.
2	Type the new name for the step or transition element and press ENTER. For example, change the default <i>Step_1</i> label to <i>INIT</i> .

Programming Step Functionality

The functionality of a step is defined in one or more IL/Ladder language rungs.

To define the functionality of a step:

Step	Action
1	Either: <ul style="list-style-type: none"> ● Double-click a step in the Grafcet Graphical Editor. ● Select a Step node in the tree view, where <i>n</i> is the step number. Result: The Grafcet Graphical Editor is closed.
2	Right-click on the selected Step node and choose Add rung from the contextual menu that appears. Result: Rungs appear as subnodes of the Step node in the tree view window.
3	Program the rung in the Ladder or IL programming language and create additional rungs if needed, as described in Ladder Language Programming (<i>see page 167</i>) or Instruction List Programming (<i>see page 190</i>).
4	To display the Grafcet Graphical Editor again, either: <ul style="list-style-type: none"> ● Click the  icon. ● Select the <i>n</i> - Grafcet POU node, where <i>n</i> is the number of the Grafcet POU.

Programming Transition Functionality

The functionality of a transition is defined in a single IL/Ladder language transition rung.

To define the functionality of a transition rung:

Step	Action
1	<p>Either:</p> <ul style="list-style-type: none"> • Double-click a transition in the Grafcet Graphical Editor. • Select a Transitions → <i>Trn</i> node in the tree view <p>Result: The Grafcet Graphical Editor is closed and a Ladder language rung displayed.</p>
2	<p>Program the rung in the Ladder or IL programming language, as described in Ladder Language Programming (<i>see page 167</i>) or Instruction List Programming (<i>see page 190</i>). Function blocks can be used in transition rungs, except those that have no outputs, for example, Shift Bit Register, Step Counter.</p> <p>When a function block is used, the <code>END_BLK</code> instruction must immediately follow the <code>ENDT</code> instruction, for example:</p> <pre> Tr1 Comment 0000 BLK %TM2 0001 LD 0 0002 IN 0003 OUT_BLK 0004 LD Q 0005 ENDT 0006 END_BLK </pre> <p>NOTE: The rung ends with an <code>ENDT</code> (end transition) instruction. This instruction cannot be selected or modified and must be the last instruction in the rung (unless the rung contains a FB).</p>
3	<p>To display the Grafcet Graphical Editor again, either:</p> <ul style="list-style-type: none"> • Click the  icon. • Select the <i>n</i> - Grafcet POU node, where <i>n</i> is the number of the Grafcet POU.

Undo/Redo

You can use the **Undo** or **Redo** buttons on the toolbar for a maximum of 10 actions stored.

Deleting a Step or Transition

Step	Action
1	<p>In the Grafcet Graphical Editor:</p> <ul style="list-style-type: none">● Select a step or transition and press the DELETE key.● Right-click on the step or transition and choose Delete the selected items in the contextual menu. <p>Result: The selected step or transition is deleted.</p> <p>NOTE: You cannot delete a step or transition from the tree view.</p>

Branching

Introduction

A Grafset (SFC) POU can contain branches.

Two types of branch exist:

- Parallel branching: two or more steps are processed simultaneously when the preceding transition is true.
- Alternative branching: one or more alternative steps are processed depending on the result of evaluating the preceding transition conditions (multi-token behavior).

Parallel Branching

A parallel branch allows a transition from a single step to multiple steps.

A parallel branch must be preceded and followed by a step.

Parallel branches can contain nested alternative branches or other parallel branches.

The following figure shows an example Grafset POU with 4 steps before creation of parallel branching:

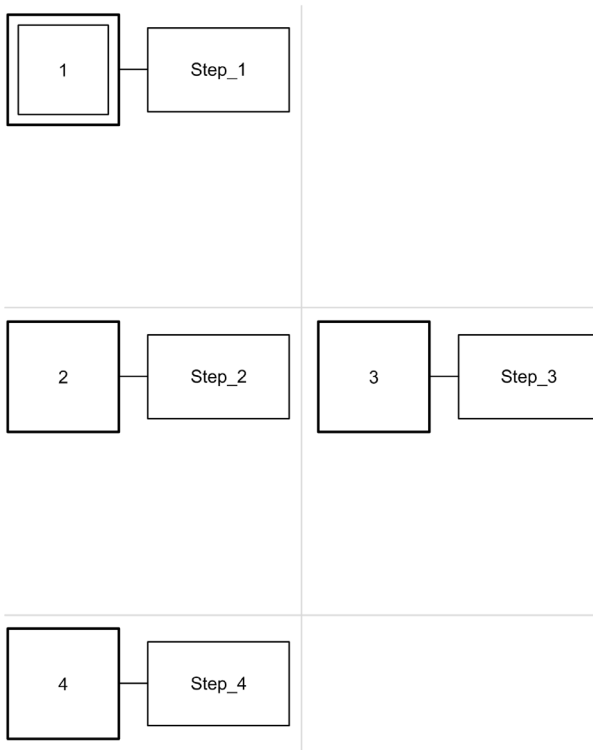

To create a parallel branch for Steps 2 and 3:

Step	Action
1	Create a transition between Step 1 and Step 2: move the mouse to the bottom of Step 1, then drag to Step 2 and release the mouse button. A new link and transition appears.
2	Draw a link between Step 3 and the transition: move the mouse to the top of Step 3, then drag to the transition and release the mouse button. Result: A horizontal double line appears below the existing transition (see the figure that follows). NOTE: To create a link between a transition and a step that is higher up in the POU, draw the link starting from the step and dragging to the transition.
3	To rejoin the branch with the main processing branch, create a transition between Step 2 and Step 4.
4	Draw a link between Step 3 and the new transition: move the mouse to the bottom of Step 3, then drag to the transition and release the mouse button. Result: A horizontal double line appears above the transition (see the figure that follows).

The following figure shows a Grafcet POU after the creation of parallel branching:

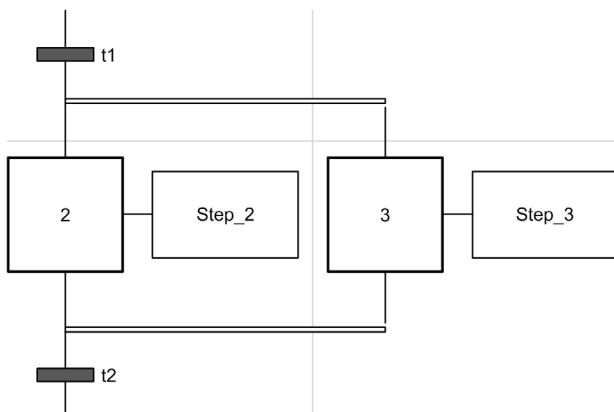

Notice that the horizontal lines before and after the branched areas are double lines.

Alternative Branching

An alternative branch must begin and end with a transition.

Alternative branches can contain nested parallel branches or other alternative branches.

With multi-token behavior, more than one parallel switch can be made from the transitions. The branches to be run are determined by the result of the transition conditions of the transitions that follow the alternative branch. The transitions of the branches are processed. The branches with satisfied transitions are triggered.

If alternative branches need to be switched exclusively (mono-token behavior), then this must be defined explicitly within the transition code.

The following figure shows an example Grafset POU with 3 steps before creation of alternative branching for Step 3 and Step 4:

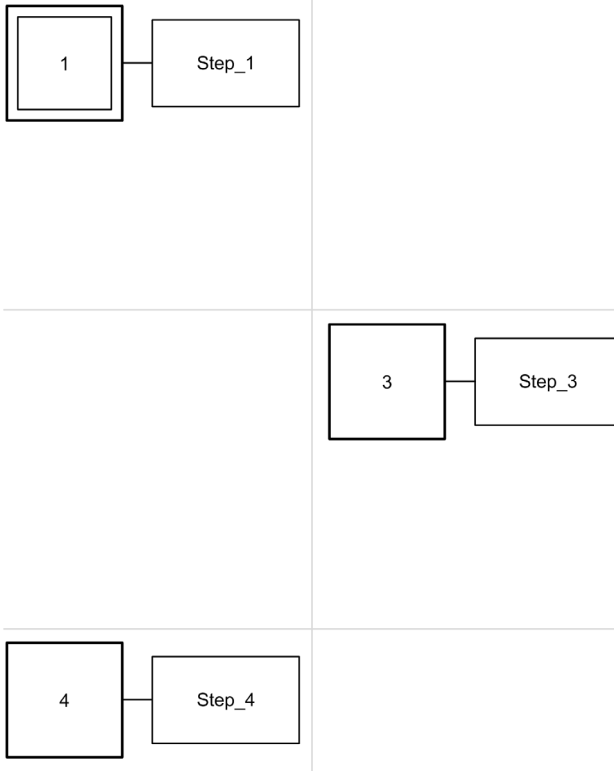

To create an alternative branch:

Step	Action
1	Create a transition between Step 1 and Step 4. Result: A new link and transition appears.
2	Draw a transition between Step 1 and Step 3: move the mouse to the bottom of Step 1, then drag to Step 3 and release the mouse button. Result: A new link and transition appears, with the branch above the existing transition (see the figure that follows).
3	Draw a transition between Step 3 and Step 4. Result: A new link and transition appears, with the branch below the existing transition between Step 1 and Step 4 (see the figure that follows).

The following figure shows the Grafcet POU after creation of alternative branching:

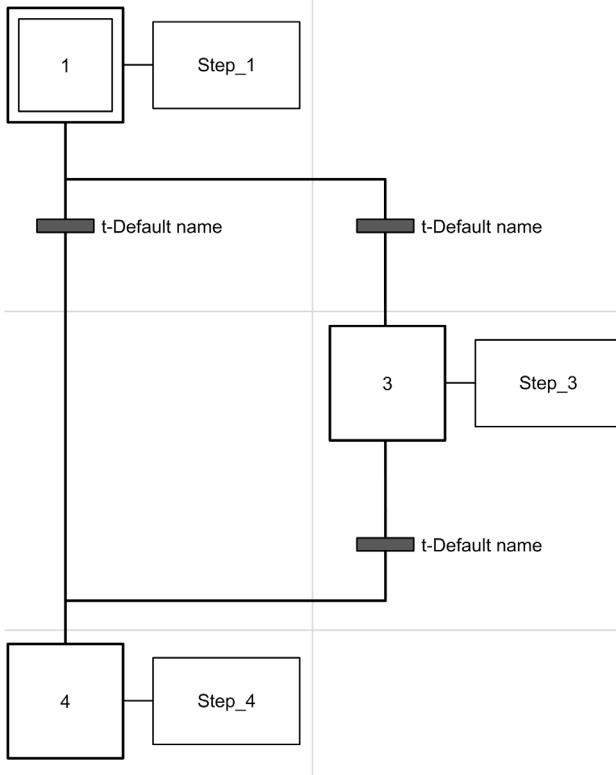

Notice that the horizontal lines before and after the branched area are single lines.

Programming Best Practices

Grafcet (SFC) Rules

- Steps must be connected by a transition:

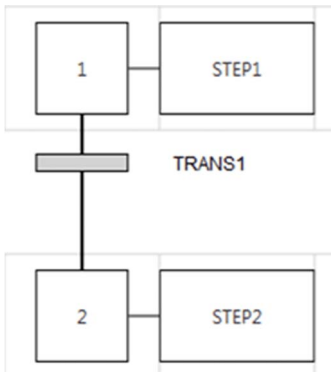

- You can add only one Grafcet POU in the same Grafcet Graphical Editor:

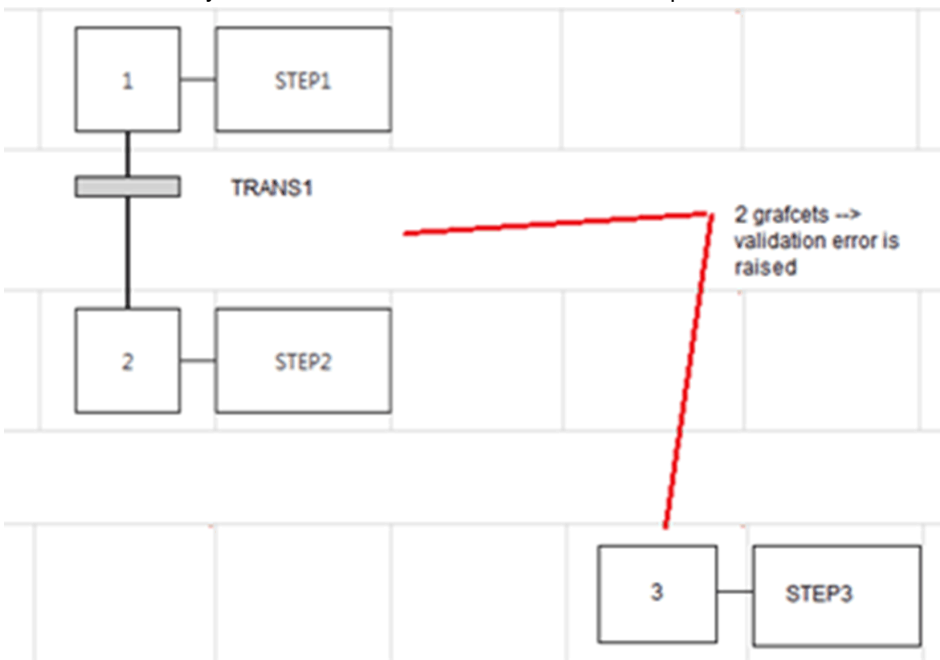

Crossed Links

You can have crossed links for the following reasons:

- Alternative (logical OR) branching (fork or junction)
- To save space on the cell grid. When lines cross there is no interaction between the lines and it is used only for symbolic representation.

Section 5.16

Debugging in Online Mode

What Is in This Section?

This section contains the following topics:

Topic	Page
Trace Window	226
Modifying Values	229
Forcing Values	230
Online Mode Modifications	231

Trace Window

Overview

The **Trace** window allows you to display in graphical form the values of specific analog and/or digital variables (limited to 12 hours of continuous recording). Each animation table can contain 1 trace at any one time. Up to 8 objects can be added to a trace. You can export the data to a file for further analysis.

NOTE: The minimum configurable refresh period for the trace is 1 second (*see page 139*). Therefore, changes in values of boolean variables between master task cycles, for example, cannot be traced.

Trace Window Presentation

Trace [-] [X]

Time Base 5 s Trace starting time: 00:00:00 Elapsed time Controller time Recording duration: 00:00:41

Numerical trace

- %C8.V
- %IW0.1

Auto scale for values
 Maximum
 Minimum

Logical trace

- %C8.D
- %C8.E
- %M0
- %I0.2
- %M1

Select **Elapsed time** to set tracing start time to 00:00:00, or **Controller time** to use the time and date of the logic controller as the start time of the trace.

The Trace window displays separate graphs for each data type selected for tracing in the animation table:

- Integer and real values appear in the **Numerical trace** area.
All numerical values share the same scale on the graph.
Select **Auto scale for values** to automatically adjust the vertical axis to display all values.
Otherwise, type **Maximum** and **Minimum** values to display a fixed range of values.
NOTE: You can type either integer or real values for **Maximum** and **Minimum**
- Binary values appear in the **Logical trace** area.
Each binary value is traced on an individual scale of 0 and 1.

Starting, Pausing, and Resetting the Trace

Click **Start** to begin tracing the variables.

Click **Stop** to pause real-time tracing.

Click **Reset** to clear all previously traced data from graphs and reset the **Recording duration** value to 0.

Exporting the Trace

Click **Export** to export all traced data to a file on the PC.

The data is saved in comma-separated value (CSV) format.

Modifying Values

Introduction

When in online mode, EcoStruxure Machine Expert - Basic allows you to modify the values of certain object types.

Online updating is only possible if the object has read/write access. For example:

- The value of an analog input cannot be modified.
- The value of the `Preset` parameter (`%TM0.P` object) of a `Timer` function block can be updated.

Refer to the description of objects in the EcoStruxure Machine Expert - Basic *Generic Functions Library Guide* or the *Programming Guide* of your hardware platform for information on which object types have read/write access.

To modify the value of an object, add it to an animation table (*see page 141*) and set its properties as required.

Forcing Values

Overview

When in online mode, you can force the values of certain boolean object types to False (0) or True (1). This allows you to set addresses to specific values and prevent the program logic or an external system from changing the value. This function is used for the debugging and fine-tuning of programs.

To force the values of boolean objects when in online mode, either:

- Use an animation table (*see page 139*)
- Modify boolean object values (*see page 232*) directly in the Ladder (LD) editor

Digital inputs and outputs cannot be forced when:

- An input is used as a Run/Stop input
- Configured as fast counter (FC) inputs
- Configured as high speed counter (HSC) inputs
- Configured as reflex outputs

NOTE: Forcing is performed at the end of the scan cycle. The image table of the outputs, however, may be modified due to the logic of your program, and may appear in animation tables and other data displays contrary to the forced state you selected. At the end of the scan, this will be corrected by acting upon the requested forced state and the physical output will indeed reflect that forced state.

Online Mode Modifications

Overview

It is possible to modify program while in online mode by:

- Adding rungs (*see page 231*)
- Modifying rungs (*see page 231*)
- Modifying Boolean Values in Ladder (*see page 232*)
- Modifying Function Block Parameters (*see page 234*)
- Modifying Constant Words (*see page 235*)
- Modifying Object Values in Operation and Comparison Blocks (*see page 235*)
- Deleting rungs (*see page 236*)
- Sending Modifications (*see page 236*)

Any changes made must then be sent to the logic controller (*see page 236*).

Adding Rungs

You can add new rungs (*see page 90*) to your program while in online mode.

NOTE: The application must be configured with a functional level (*see page 80*) of at least **Level 4.1** to be able to add new rungs in online mode.

The following limitations apply until the new rung has been successfully sent to the logic controller:

- Rungs containing errors () cannot be sent to the logic controller.
- Rungs must be written in Ladder language and cannot be converted to IL until they have been successfully compiled.
- Rungs cannot contain Grafcet (List) steps.
- Labels cannot be added to the rung.

Modifying Rungs

You can modify program rungs, in both the Instruction List (IL) and Ladder (LD) editors, while in online mode. However, the Grafcet (SFC) is not available online. Modified rungs appear with an orange background (*see page 172*).

There are limits to the type of editing that you may perform and the instructions that you may edit, depending on whether the logic controller is in `RUNNING` or `STOPPED` state. These limits help protect the state of the controller and the integrity of the program.

You can switch the display of a rung between Instruction List (IL) and Ladder (LD), even when in online mode.

The following table indicates in which cases modifications are allowed:

Operations	In STOPPED in IL	In RUNNING in IL	In STOPPED in Ladder	In RUNNING in Ladder
Event task content	editable	editable ⁽¹⁾	editable	editable ⁽²⁾
Master / Periodic task content	editable	editable	editable	editable
Free POU content	editable	editable ⁽¹⁾	non-editable	editable ⁽²⁾
Rung with label	editable	editable ⁽³⁾	editable	editable ⁽⁴⁾
Rung with jump, or calling a subroutine or label	editable	editable	editable	editable
Rung with any Grafcet instruction	non-editable	non-editable	non-editable	non-editable
Add/modify label	non-editable	non-editable	non-editable	non-editable
Multiple operands (operation and comparison blocks)	editable	editable	editable	editable
User-defined function	rejected	rejected	editable	editable ⁽²⁾
User-defined function block	rejected	rejected	editable	editable ⁽²⁾
<p>(1) Except the first line of the first rung</p> <p>(2) Except the first element of the first rung</p> <p>(3) Except the first line of the rung</p> <p>(4) Except the first element of the rung</p>				

NOTE: This table does not take into account the program structure modifications, which are not allowed in online mode.

Modifying Boolean Values in Ladder

For rungs displayed in Ladder language, the values of certain boolean object types can be written to 1/0, forced to 1/0, or unforced.

The following boolean object types can be modified:

Object type	Write 1/0	Force to 1/0 or Unforce
Digital input (%Ix.y)	N/A	Yes
Digital output (%Qx.y)	Yes	Yes
System bit (%Si) ¹	Yes	N/A
Memory bit (%Mi)	Yes	N/A
Memory word bit (%MWi :Xj)	Yes	N/A
(1) If the system bit or system word can be written by the user program.		

Object type	Write 1/0	Force to 1/0 or Unforce
Analog output bit (%QWi :Xj)	Yes	N/A
System word bit (%SWi :Xj) ¹	Yes	N/A
Input assembly bit (%QWEi :Xj)	Yes	N/A
(1) If the system bit or system word can be written by the user program.		

Move the mouse cursor over the object in the Ladder editor. If the object can be both written to 1/0 and forced to 1/0, the following buttons appear below the graphical element:

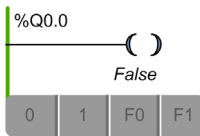

If the object can be written to 1/0 but not forced, the following buttons appear:

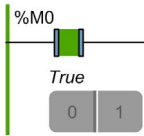

If the object can be forced but not written to 1/0, the following buttons appear:

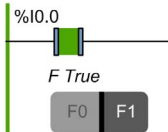

Click a button to modify the real-time value of the object:

- **0**. Write 0.
- **1**. Write 1.
- **F0**. Force to 0.
- **F1**. Force to 1.

The button corresponding to the present status of the object is shown in dark gray (**F1** in the example above).

To remove forcing, either:

- Click again on the **F0/F1** button.
- Use an animation table (*see page 139*).

NOTE: Forcing is performed at the end of the scan cycle. The image table of the outputs, however, may be modified due to the logic of your program, and may appear in animation tables and other data displays contrary to the forced state you selected. At the end of the scan, this will be corrected by acting upon the requested forced state and the physical output will indeed reflect that forced state.

Modifying Function Block Parameter Values

To modify a function block parameter in online mode:

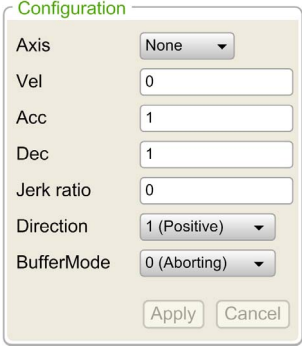
Step	Action
1	<p>In the Programming window, move the mouse cursor over the function block in the Ladder editor.</p> <p>Result: The Configuration tooltip appears.</p> <p>The following illustration shows an example of the Configuration tooltip:</p>  <p>The Configuration tooltip is a light-colored box with a title bar. It contains several parameters, each with a label and a control element: <ul style="list-style-type: none"> Axis: A dropdown menu showing 'None'. Vel: A text input field containing '0'. Acc: A text input field containing '1'. Dec: A text input field containing '1'. Jerk ratio: A text input field containing '0'. Direction: A dropdown menu showing '1 (Positive)'. BufferMode: A dropdown menu showing '0 (Aborting)'. At the bottom of the tooltip are two buttons: 'Apply' and 'Cancel'. </p>
2	Click the value to modify.
3	Type the value.
4	<p>To validate the modifications, you can use one of the following methods:</p> <ul style="list-style-type: none"> ● Click Apply. ● Click outside of the Configuration tooltip. Result: The Question window appears. Click OK.

Modifying Constant Words



Configuration values and runtime data values of constant word (%KW), constant double word (%KD), and constant floating point (%KF) objects can be modified while in online mode. In the properties grid, the columns **Decimal**, **Binary**, **Hexadecimal** and **ASCII** are editable:

Constant word properties		%KW	%KD	%KF				
Used	Equ Used	Address	Symbol	Decimal	Binary	Hexadecimal	ASCII	
<input type="checkbox"/>	<input type="checkbox"/>	%KW0		0	2#0000000000000000	16#0000	no meaning	
<input checked="" type="checkbox"/>	<input type="checkbox"/>	%KW1		0	2#0000000000000000	16#0000	no meaning	

To modify a constant word or floating point value in online mode:

Step	Action
1	In the Tools tab of the Programming window, choose Memory objects → Constant words .
2	Click %KW , %KD , or %KF to select the type of constant to modify.
3	Modify the value as required. You can import the constant values. Refer to Importing the constant word properties (see page 148).
4	Click Apply . Result: The modified value is sent to the logic controller.

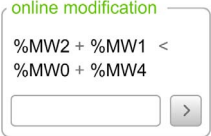
Modifying Object Values in Operation and Comparison Blocks

Step	Action
1	In the Programming window, move the mouse cursor over an operation or comparison block in the Ladder editor. Result: The online modification tooltip appears: 
2	Click the object or the symbol to modify.
3	Enter the value.
4	To validate, you can use one of the following methods: <ul style="list-style-type: none"> • Click . • Press Enter. If a value is incorrect, the value remains unchanged.

Deleting Rungs

You can delete rungs from your program while in online mode.

NOTE: The application must be configured with a functional level (*see page 80*) of at least **Level 4.1** to delete rungs in online mode.

The following limitations apply:

- The rung must be displayed in Ladder language.
- The rung cannot be the only rung in a POU or Free POU. This limitation does not apply to Grafcet POUs.
- The rung must not contain Grafcet (List) steps, be a subroutine rung, or contain any of the following instructions:
 - JMP
 - END
 - ENDC
 - ENDCN
 - G7
- Only one rung at a time can be deleted.

Sending Modifications

In IL, the modifications, when allowed, are automatically sent to the logic controller after validation of the edited IL line. If the modification is not allowed, a message appears.

In Ladder, the modifications are not sent automatically. When in online mode, a button bar appears:



Click **Send** to send the modifications to the logic controller. This button is only active when the program has been modified in online mode and contains no errors.

Click **Rollback** to discard the changes made in online mode and restore the original rung (that is, the version stored in the logic controller). The background color of the rung changes from orange to green. This button is only active when the program has been modified in online mode.

Click **Download non program data** to download updates to non program data (project properties, symbols, comments, animation tables, and so on) to the logic controller. This button is only active when the non program data is not synchronized between the PC and the logic controller, for example, if an animation table has been modified prior to entering online mode.

Click **Backup** to synchronize the contents of the flash memory and the RAM memory on the logic controller. This status is shown in the Controller Info window (*see page 260*). During the backup, the Ethernet communications in progress (for example, using Modbus TCP or the EXCH3 instruction) are temporarily suspended.

NOTE: Be sure that online modifications have been saved to flash memory prior to creating a clone.

Rungs that are modified are evaluated for their validity in the context of whether the controller is in `RUNNING` or `STOPPED` state. Modifications that would cause runtime errors, or change the structure of the program memory, are rejected in online mode.

Chapter 6

Commissioning

What Is in This Chapter?

This chapter contains the following sections:

Section	Topic	Page
6.1	Overview of the Commissioning Window	240
6.2	Connect to a Logic Controller	241
6.3	Controller Update	253
6.4	Memory Management	254
6.5	Controller Info	260
6.6	RTC Management	262

Section 6.1

Overview of the Commissioning Window

Overview of the Commissioning Window

Introduction

The **Commissioning** window allows you:

- Login to or logout from a logic controller.
- Upgrade (or downgrade) the logic controller firmware.
- Manage logic controller memory (for example, by performing backup and restore operations).
- Display information about the logic controller, expansion module (references and, for TM3 expansion modules, firmware versions), and cartridges you are connected to.
- Manage the real time clock (RTC) of the logic controller.

Found: New project

	Reference	Firmware
Controller	TM221CE40U	0.5.0.7
Module 1	TM3AI4-	25
Module 2	TM3AQ4-	20
Cartridge 1	TMC2AI2	
Cartridge 2	TMC2AQ2V	

✔ PC and controller applications are identical
Connection is established

PC to Controller (download)

Controller to PC (upload)

Stop controller

Start Controller

Launch simulator

Stop simulator

NOTE: The application must be configured with a functional level (*see page 80*) of at least Level 5.0 to be able to view the firmware version of TM3 Analog expansion modules.

Section 6.2

Connect to a Logic Controller

What Is in This Section?

This section contains the following topics:

Topic	Page
Connecting to a Logic Controller	242
Downloading and Uploading Applications	249

Connecting to a Logic Controller

Overview

Click **Connect** on the **Commissioning** window to manage the connection with the logic controller.

Connected Controllers

Two lists of logic controllers are displayed:

1. Local Devices

Displays all logic controllers connected to the PC:

- With the physical COM ports of the PC (COM1, for example)
- With USB cables
- Through the virtualized COM ports (by USB-to-serial converters or Bluetooth dongles)
- With a modem connection that you choose to add manually. Use a modem connection between EcoStruxure Machine Expert - Basic and a logic controller for monitoring purposes only.

NOTE: If a COM port is selected and the **Keep Modbus driver parameters** check box is ticked, the communication is established with the parameters defined in the Modbus driver.

2. Ethernet Devices

Displays all logic controllers that are accessible by Ethernet (on the same subnet and not under a router or any device that blocks UDP broadcasts). This list includes logic controllers that are automatically detected by EcoStruxure Machine Expert - Basic as well as any controllers that you choose to add manually.

Manually Adding Ethernet Controllers

To manually add a logic controller to the **Ethernet Devices** list:

Step	Action
1	In the Remote lookup field, type the IP address of the logic controller to add, for example 12.123.134.21
2	Click Add to add the device to the Ethernet Devices list.

Manually Adding Modem Connections

Prerequisites for availability of modem:

- If no modem is installed on the PC, the button is disabled.
- Verify in the **Phone and Modem** option of the Windows **Control Panel** that the modem is installed and perform a test (in the **Modem** tab, click the modem to test and click **Properties** → **Diagnostics** → **Query Modem**). The response of the modem must be valid.
- If the modem is an external modem connected on a COM port, verify that the communication settings are the same in:
 - the modem advanced parameters,
 - the communication port parameters,
 - the Modbus driver parameters.

For more details on the installation and setting of SR2MOD03 modem, refer to the SR2MOD02 and SR2MOD03 Wireless Modem User Guide.

To manually add a modem connection to the **Local Devices** list:

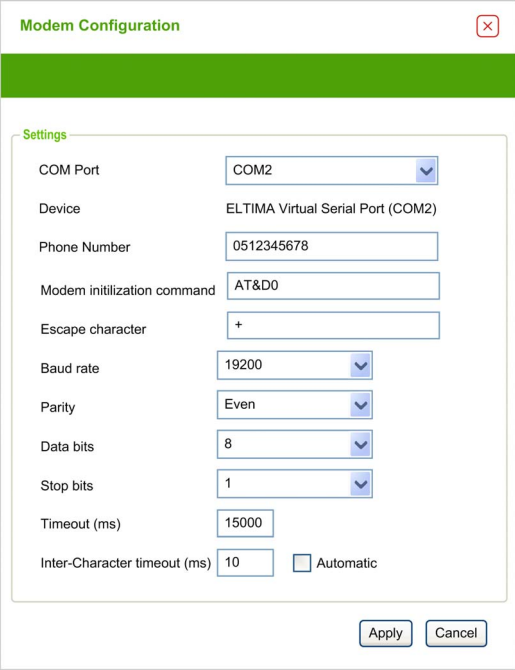

Step	Action
2	<p>Click  (Add modem configuration button) to open the Modem configuration window. Result: The Modem configuration window appears.</p>
3	<p>Select the COM port of the modem from the drop-down list:</p> 
4	<p>Configure the communication parameters. For detailed information on the modem configuration parameters, refer to the table below.</p>
5	<p>Click Apply. NOTE: This button is enabled only if all settings are correctly configured. Result: The modem connection is added to the Local Devices list (for example COM2@0612345678,GenericModem).</p>

This table describes each parameter of the modem configuration:

Parameter	Value	Default value	Description
Port	COMx	-	Allows you to select the COM port of the modem from the dropdown list.
Device	-	-	Displays the modem name.
Phone Number	-	-	Type the phone number of the remote modem connected to the logic controller. This text field accepts all the characters and is limited to 32 characters in total. This field must contain at least one character to be able to apply the configuration.
AT init cmd	-	AT&D0	Allows you to edit the AT initialization command of the modem. The AT initialization command is not mandatory (if the field is empty the AT string is sent).
Escape chars	-	+	Allows you to edit the escape character for the hang-up procedure.
Baud rate	1200 2400 4800 9600 19200 38400 57600 115200	19200	Allows you to select the data transmission rate (bits per second) of the modem.
Parity	None Even Odd	Even	Allows you to select the parity of the transmitted data for error detection.
Data bits	7 8	8	Allows you to select the number of data bits.
Stop bits	1 2	1	Allows you to select the number of stop bits.
Timeout (ms)	0...60000	15000	Allows you to specify the transmission timeout (in ms).
Break timeout (ms)	0...10000	10	Allows you to specify the interframe timeout (in ms). If the check box Automatic is ticked, the value is automatically calculated.

Connecting to a Logic Controller

To log in to a logic controller:

Step	Action
1	 Click (Refresh Devices button) to refresh the list of connected Ethernet devices.
2	<p>Select one of the logic controllers in the Local Devices or Ethernet Devices lists. If a controller is connected by Ethernet on the same network cable than your PC, the IP address of the controller appears in the list. Selecting the IP address in the list enables  (IP Address Configuration button). Click this button to change the IP address of the controller.</p> <p>NOTE: If you tick the check box Write to post configuration file, the Ethernet parameters are modified in the post configuration file and kept after a power cycle.</p>
3	<p>If required, click  (Start Flashing LEDs button) to flash the LEDs of the selected controller to identify the controller physically by its flashing LEDs. Click this button again to stop flashing the LEDs.</p> <p>NOTE: You can only use the Start Flashing LEDs button for logic controllers that are automatically added (with Auto discovery protocol enabled option selected).</p>
4	<p>Click Login to log in to the selected controller. Result: A status bar appears showing the connection progress.</p>
5	<p>When connected, the protection status of the application currently stored in the logic controller appears in the Selected Controller area of the window. When the connection is successfully established, details about the logic controller appear in the Selected Controller area of the window:</p> <ul style="list-style-type: none"> • The firmware revision • The logic controller reference number • The reference numbers of all expansion modules connected to the logic controller • The current state of the connection between EcoStruxure Machine Expert - Basic and the logic controller.
6	<p>EcoStruxure Machine Expert - Basic verifies whether the hardware configuration of the logic controller is compatible with the configuration of the current project. If so, the application can be downloaded to the controller. The PC to Controller (download) button is enabled and you can proceed to download the application (<i>see page 249</i>). EcoStruxure Machine Expert - Basic verifies whether the non-program data (symbols, comments, animation tables, and so on) stored in the logic controller is the same as that of the current application. If not, an advisory message is displayed. EcoStruxure Machine Expert - Basic also verifies whether a more recent firmware version is available and, if so, displays a link you can click to begin the firmware upgrade.</p>

Comparing Projects when Connected

You can compare the EcoStruxure Machine Expert - Basic application with the application in the logic controller. Differences are displayed and can then be evaluated and taken into consideration.

When both downloading and uploading are authorized, and the PC and Logic Controller applications are not the same, a message appears in the **Commissioning** window:

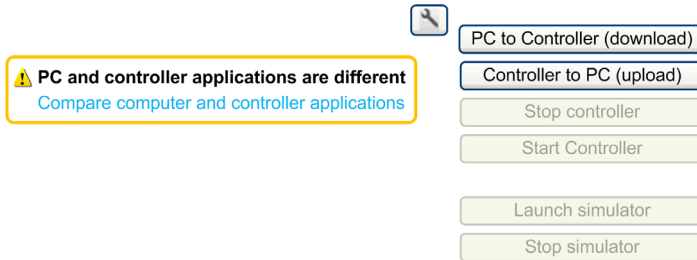

Proceed as follows:

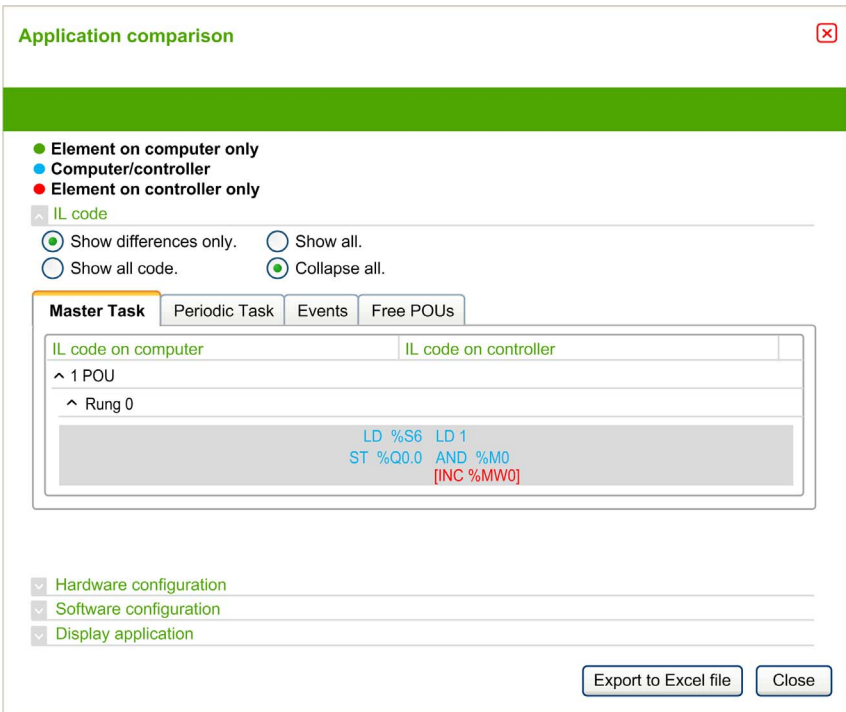
Step	Action
1	In the message, click on Compare computer and controller applications . Result: A popup window informs you that you must disconnect from the logic controller before viewing the comparison.
2	Click OK to continue and disconnect from the logic controller.
3	<p>The Application comparison window is displayed:</p>  <p>Comparisons are available of the following areas of the configuration and application:</p> <ul style="list-style-type: none"> ● IL code ● Hardware configuration ● Software configuration ● Display application
4	Optionally, click Export to Excel file to save the comparison in spreadsheet format.

Downloading and Uploading Applications

Downloading the Application

Follow these steps to download the application currently open in EcoStruxure Machine Expert - Basic to the logic controller:

Step	Action
1	Click Connect in the commissioning tree of the Commissioning window.
2	Select one of the logic controllers in the Local Devices or Ethernet Devices lists.
3	Click Login to log in to the selected controller.
4	<p>Optionally, click  Download Settings. If you do not want memory words (%MW) and memory bits (%M) to be reset after the download, clear the Reset memories option.</p> <p>NOTE: The option in Memories is only available for logic controllers with firmware version greater than or equal to 1.3.3.y. The options in Program Properties and Project Properties are only available for logic controllers with firmware version greater than or equal to 1.4.1.y.</p>
5	<p>If the PC to Controller (download) button is not available, verify that:</p> <ul style="list-style-type: none"> • The application stored in the logic controller is identical to the EcoStruxure Machine Expert - Basic application. • The hardware configuration of the logic controller system is compatible with the configuration in the EcoStruxure Machine Expert - Basic application. • The logic controller is not password-protected. If it is, enter the password. <p>Click PC to Controller (download).</p>
6	If the non-program data of the current application is not identical to that stored in the controller, the non-program data only is downloaded to the controller.
7	<p>If the application has been configured to Start in Run, a hazard message is displayed and prompts you to confirm that the application has been so configured. Click OK to confirm the download of the application or click Cancel and modify the configuration.</p>
8	<p>Click OK to continue the transfer and overwrite the logic controller application. Result: A status bar appears indicating the connection status.</p>
9	<p>To run the application you have downloaded, click Run controller and click OK to confirm the action. If a message appears informing you that the operating mode cannot be changed, click Close and verify the RUN/STOP switch on the logic controller, and/or, the RUN/STOP input as they may prevent the controller from passing into RUNNING. Otherwise, refer to the <i>Hardware Guide</i> of your logic controller for details.</p>

Setting Download Options

To display the **Download options**, click  **Download settings** in the **Commissioning** window.

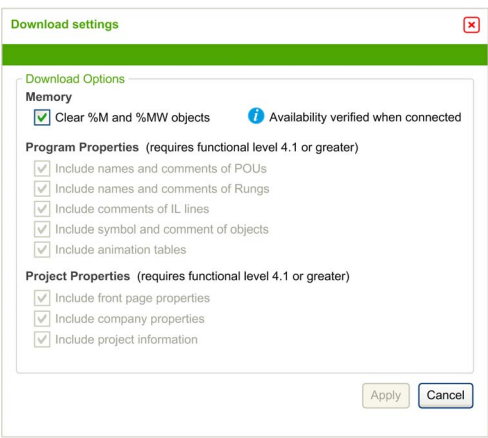
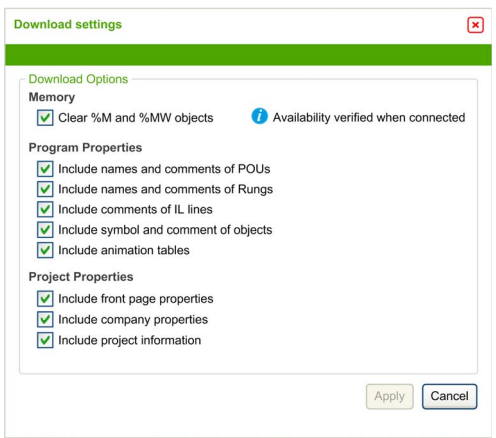
Functional Level ≤ 4.1	Functional Level ≥ 4.1
	
The settings are not uploaded	The settings are uploaded.

Each setting is selected by default. If you select or clear an option in online mode, click **PC to Controller (download)** to download the modifications.

In online mode, if you modify the name or comments of a POU, rung, or IL line and if these corresponding options are selected in **Download Settings**, the download is done automatically.

Reset Memories option is selected by default. This option is available in offline and online mode.

When **Reset Memories** is selected, the memory words and bits are reset to 0 at application download.

When **Reset Memories** is cleared, the memory words and bits keep their values.

If the amount of allocated memory is different for the application residing in PC memory than that of the application residing in the memory of the logic controller, the memory is managed as follows:

- If allocated $\%MW_x$ in the application of the logic controller is greater than that allocated $\%MW_x$ in the application residing in the PC memory, then the allocation of the application on the PC is used, and the additional $\%MW_x$ words are set to 0.
- If allocated $\%MW_x$ in the application of the logic controller is less than that allocated $\%MW_x$ in the application residing in the PC memory, then the additional $\%MW_x$ words are removed from the memory space.
- If there is no application in the logic controller, $\%MW$ are set to 0. The same rules are applied for $\%M$. Download settings are project-dependent and saved with the project.

Uploading an Application

Follow these steps to upload the application stored in the logic controller to EcoStruxure Machine Expert - Basic:

Step	Action
1	Click Connect in the commissioning tree of the Commissioning window.
2	Select one of the logic controllers in the Local Devices or Ethernet Devices lists.
3	Click Login to log in to the selected controller. If the logic controller is password protected, type the password and click OK to connect.
4	Click Controller to PC (upload) . If the Controller to PC (upload) button is not available, confirm whether the application stored in the logic controller is identical to the EcoStruxure Machine Expert - Basic application.
5	Click OK to confirm upload from the logic controller. Result: A status bar appears indicating the connection status. When the transfer completes, the application is uploaded from the logic controller into EcoStruxure Machine Expert - Basic.

NOTE: The value of the **Reset Memories** option is not saved when you upload an application.

Downloading or Uploading a Password-Protected Application

If you download or upload an application that was password-protected in a lesser version of EcoStruxure Machine Expert - Basic, the actions you can or must do depend on the versions:

Operation	EcoStruxure Machine Expert - Basic version	Functional level of the Application	Firmware version	Actions
Downloading				
	≤1.5	≤5.0	≤1.5	Downloading process does not use the latest security strategy.
			≥ 1.5.1	Downloading process possible and password visible.
		≥ 5.1	–	You cannot download.
	≥ 1.5 SP1	≤5.0	≤ 1.5	If the application is password-protected, you cannot download.
			≥ 1.5.1	You must do one of the following actions: <ul style="list-style-type: none"> ● Upgrade the functional level to 5.1. ● Let the password blank. ● Disable the application protection.
		≥ 5.1	≤ 1.5	You cannot download.
			≥ 1.5.1	Downloading process uses the latest security strategy.

Operation	EcoStruxure Machine Expert - Basic version	Functional level of the Application	Firmware version	Actions
Uploading				
	≤1.5	≤5.0	≤1.5	Uploading process does not use the latest security strategy.
			≥ 1.5.1	You must do one of the following actions: <ul style="list-style-type: none"> ● Downgrade the firmware version. ● Upgrade the EcoStruxure Machine Expert - Basic version.
		≥ 5.1	–	You cannot upload.
	≥ 1.5 SP1	≤5.0	≤1.5	Uploading process does not use the latest security strategy.
			≥ 1.5.1	Uploading process uses the latest security strategy.
		≥ 5.1	≤1.5	You cannot upload.
			≥ 1.5.1	Uploading process uses the latest security strategy.

Section 6.3

Controller Update

Controller Firmware Updates

Overview

You can download firmware updates to the logic controller either directly from EcoStruxure Machine Expert - Basic or using an SD card.

Downloading a Firmware Update to the Logic Controller

Performing a firmware update preserves the application program present in the controller, including the Boot Application in the non-volatile memory.

Follow these steps to download firmware updates to the logic controller:

Step	Action
1	Verify that you are not connected to the logic controller when using Firmware Update .
2	Click Commissioning → Controller Update .
3	Click Update . The first page of the executive loader (OS loader) wizard appears.

If you remove power to the device, or there is a power outage or communication interruption during the transfer of the application, your device may become inoperative. If a communication interruption or a power outage occurs, reattempt the transfer. If there is a power outage or communication interruption during a firmware update, or if an invalid firmware is used, your device will become inoperative. In this case, use a valid firmware and reattempt the firmware update.

NOTICE

INOPERABLE EQUIPMENT

- Do not interrupt the transfer of the application program or a firmware change once the transfer has begun.
- Re-initiate the transfer if the transfer is interrupted for any reason.
- Do not attempt to place the device (logic controller, motion controller, HMI controller or drive) into service until the file transfer has completed successfully.

Failure to follow these instructions can result in equipment damage.

Section 6.4

Memory Management

Managing Logic Controller Memory

Overview

In EcoStruxure Machine Expert - Basic, you can back up, restore, or erase the different elements from or to the logic controller to which you are connected.

Backup, restore, and erase options are available only in online mode.

WARNING

UNINTENDED EQUIPMENT OPERATION

- Verify that the controller you are connected to is the intended target before performing the erase or the restore operation.
- Verify the state of security of your machine or process environment before performing the erase or the restore operation from a remote location.

Failure to follow these instructions can result in death, serious injury, or equipment damage.

Backing Up to a PC or Controller SD Card

Follow these steps to back up the logic controller memory to a PC or to the controller SD card:

Step	Action
1	Log in to the logic controller.
2	Select Memory Management in the left-hand area of the Commissioning window.
3	In the Action list, choose Backup from Controller .
4	To back up to a PC: Under Destination , choose PC . Click the browse button, navigate to the folder in which to write the backup file. or To back up to an SD card: Under Destination , choose Controller SD Card folder. Insert an SD card into the SD card slot of the logic controller. NOTE: The SD card must not be empty or contain a <code>script.cmd</code> file to avoid creating a clone or the script execution (<i>see Modicon M221, Logic Controller, Programming Guide</i>).

Step	Action
5	<p>Select the elements to back up by selecting the options:</p> <ul style="list-style-type: none"> ● Backup firmware ● Backup program ● Backup memory values ● Backup log file ● Backup post configuration file <p>When Backup memory values is selected in a PC backup, specify the First Memory Bit, Last Memory Bit, First Memory Word, and Last Memory Word to be included in the backup.</p>
6	<p>Click Backup from Controller to begin the backup operation.</p> <p>The elements are saved to the specified PC folder or SD card as an SD card image (.smbk).</p> <p>A report window appears displaying a list of information or detected error messages about the backup operation.</p>

NOTE: If you choose to back up memory values, you can initiate a backup while the logic controller is in **RUNNING** state. As a consequence, the backup would not necessarily be coherent because the memory variables value can be modified from one scan to another. If you wish to have a consistent set of values for the variables, you may need to first put the logic controller into **STOPPED** state.

Restoring

Follow these steps to restore logic controller elements from a PC:

Step	Action
1	Log in to the logic controller.
2	Select Memory Management in the left-hand area of the Commissioning window.
3	In the Action list, choose Restore to Controller .
4	Choose the source folder that contains the backup files on the PC.
5	Select the elements you want to restore to the logic controller.
6	<p>Click Restore to Controller to begin the restore operation.</p> <p>A report window appears displaying a list of information or detected error messages about the restore operation.</p>

Incomplete file transfers, such as data files, application files and/or firmware files, may have serious consequences for your machine or controller. If you remove power, or if there is a power outage or communication interruption during a file transfer, your machine may become inoperative, or your application may attempt to operate on a corrupted data file. If an interruption occurs, reattempt the transfer. Be sure to include in your risk analysis the impact of corrupted data files.

WARNING

UNINTENDED EQUIPMENT OPERATION, DATA LOSS, OR FILE CORRUPTION

- Do not interrupt an ongoing data transfer.
- If the transfer is interrupted for any reason, re-initiate the transfer.
- Do not place your machine into service until the file transfer has completed successfully, unless you have accounted for corrupted files in your risk analysis and have taken appropriate steps to prevent any potentially serious consequences due to unsuccessful file transfers.

Failure to follow these instructions can result in death, serious injury, or equipment damage.

To restore a backup from a controller SD card, refer to the *Programming Guide* of the logic controller.

Erasing Logic Controller Elements

Follow these steps to erase logic controller elements:

Step	Action
1	Select Memory Management in the left-hand area of the Commissioning window.
2	In the Action list, choose Erase in Controller .
3	Select the elements you want to erase in the logic controller. If you select the Erase post configuration file option, the post configuration file is deleted immediately upon clicking Erase in Controller . In order to preserve any existing Ethernet connections, however, deletion of the file is only taken into account by the controller following an Ethernet reinitialization, that is, any of the following events: <ul style="list-style-type: none"> ● Unplugging and replugging the Ethernet cable ● Initializing the controller ● Power cycle the controller.
4	Click Erase in Controller button to begin the erase operation. A report window appears displaying a list of information or detected error messages about the erase operation.

Creating and Reading Logic Controller Images

A logic controller image includes the controller firmware, the program, and the post configuration file. A script allows you to transfer those elements to a logic controller.

When creating a logic controller image, choosing an SD card as destination allows you to use this SD card in a logic controller.

Creating a Logic Controller Image

In offline mode, this procedure allows you to generate a script and copy files necessary to copy the following elements to your PC or an SD card:

- Firmware contained in the installed EcoStruxure Machine Expert - Basic software.
- Program of the currently opened project.
- Post configuration file.

Follow these steps to create a logic controller image:

Step	Action
1	If you are connected to a logic controller, click Logout in the Commissioning window.
2	Select Memory Management in the left-hand area of the Commissioning window.
3	In the Action list, choose Create Controller image .
4	In Destination → PC , click the browse button and navigate to the folder in which to write the image file. You can choose an SD card inserted in your PC as destination.
5	Select the elements to copy by selecting: <ul style="list-style-type: none"> ● Include firmware ● Include program
6	If you want to overwrite the post configuration file, select Erase post configuration file .
7	Click Create Controller image . Result: The following folders and files are created: <ul style="list-style-type: none"> ● script.cmd ● usr/app/*.smbk ● sys/os/*.mfw
8	If you created the controller image on your PC, copy the files in an SD card.

The following illustration presents an example of the settings:

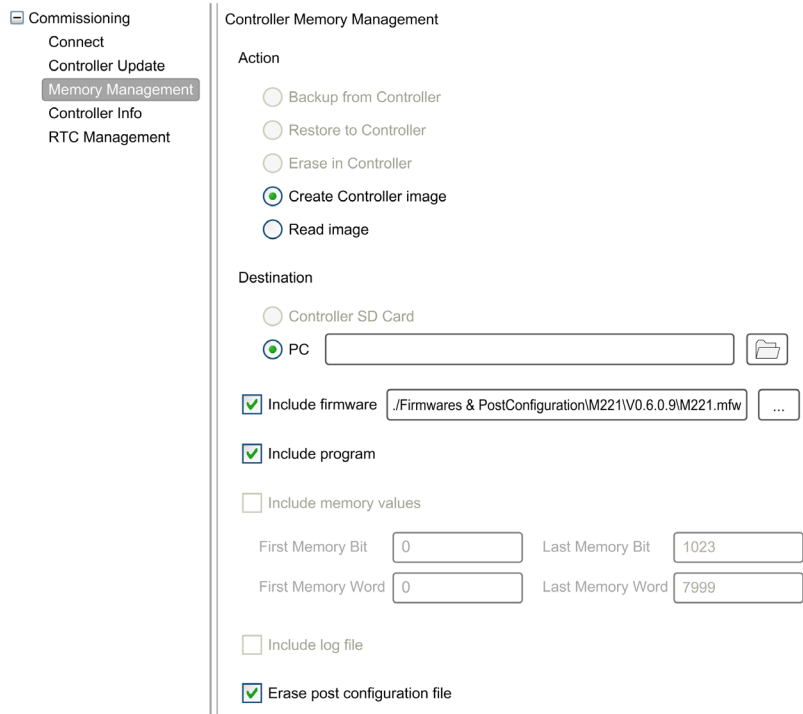

Reading a Logic Controller Image

In offline mode, this procedure allows you to open a `.smbk` image file in EcoStruxure Machine Expert - Basic as a project.

NOTE: The image opened must have been previously created either through **Create Controller image** operation or by a backup from the controller (*see page 257*).

Follow these steps to read a logic controller image:

Step	Action
1	If you are connected to a logic controller, click Logout in the Commissioning window.
2	Select Memory Management in the left-hand area of the Commissioning window.
3	In the Action list, choose Read image .
4	In Source → PC , click the browse button and navigate to the folder containing the image file (<code>.smbk</code>). Read program is selected by default. To read a image file, you have to select it.
5	Click Read image to read the program and open a project.

The following illustration presents an example of the settings:

Commissioning

- Connect
- Controller Update
- Memory Management
- Controller Info
- RTC Management

Controller Memory Management

Action

- Backup from Controller
- Restore to Controller
- Erase in Controller
- Create Controller image
- Read image

Source

- Controller SD Card
- PC 

Read firmware

Read program

Read memory values

First Memory Bit Last Memory Bit

First Memory Word Last Memory Word

Read log file

Read post configuration file

Section 6.5

Controller Info

Controller Information

Overview

Click **Controller info** in the left-hand area of the **Commissioning** window to display the following information on the present state of the logic controller:

- **Executable RAM:** This option verifies if a valid application is stored in the RAM memory of the logic controller. This information can also be obtained from within a program by testing bit 14 of the system word %SW7 (*see Modicon M221, Logic Controller, Programming Guide*).
- **Protected RAM:** This option is checked if the application in the RAM memory of the logic controller is password-protected. This information can also be obtained from within a program by testing bit 8 of the system word %SW7 (*see Modicon M221, Logic Controller, Programming Guide*).
- **Forced I/O:** This option is checked if 1 or more digital inputs or outputs on the logic controller are being forced to a specific value (*see page 141*). In this case, system bit %S14 (*see Modicon M221, Logic Controller, Programming Guide*) (IO force activated) is set to 1.
- **RAM synchronized with Flash:** This option is checked, if the application stored in non-volatile memory is not identical to the application in **RAM** memory.
The option is unchecked if either:
 - online modifications to the application have not yet been sent to the logic controller (by clicking the **Backup** button on the Programming tab).
 - the logic controller has not been initialized since the modifications were made (by clicking the **Initialize controller** button on the toolbar).
- **Status:** The present state of the logic controller.
This information can also be obtained from within a program by testing the system word %SW6. For more information on controller states, see the *programming guide* of your logic controller.
- **Last stopped on:** The date and time that the logic controller was last stopped (STOPPED, HALTED, and so on).
This information can also be obtained from within a program by testing the system word %SW54 through %SW57.
- **Last stopped reason:** Displays the reason for the most recent stop of the logic controller.
This information can also be obtained from within a program by testing the system word %SW58.

- **Scan time (μs):** The following scan times:
 - **Minimum** (in microseconds): Shortest scan time since the last power-on of the logic controller.
This information can also be obtained from within a program by testing the system word %SW32 (in milliseconds).
 - **Current** (in microseconds): The scan time.
This information can also be obtained from within a program by testing the system word %SW30 (in milliseconds).
 - **Maximum** (in microseconds): The longest scan time since the last power-on of the logic controller.
This information can also be obtained from within a program by testing the system word %SW31 (in milliseconds).
- **Controller time:** The following information is displayed only if the logic controller has a real time clock (RTC):
 - **Date** (DD/MM/YYYY): The present date stored in the logic controller.
This information can also be obtained from within a program by testing the system words %SW56 and %SW57.
 - **Time** (HH:MM:SS): The present time stored in the logic controller.
This information can also be obtained from within a program by testing the system words %SW54 and %SW55.

The date and time are presented in same format as specified for the PC.
- **Ethernet information:** The following information is displayed only if the logic controller has an embedded Ethernet connection:
 - **IP address:** The IP address of the logic controller.
This information can also be obtained from within a program by testing the system words (see *Modicon M221, Logic Controller, Programming Guide*) %SW33 and %SW34.
 - **Subnet mask:** The subnet mask of the logic controller.
This information can also be obtained from within a program by testing the system words %SW35 and %SW36.
 - **Gateway address:** The gateway address of the logic controller.
This information can also be obtained from within a program by testing the system words %SW37 and %SW38.
- **SL1 Post Configuration status:** The parameters with the activated check box are defined by the post configuration file. This information can also be obtained from within a program by testing the system word %SW98 (see *Modicon M221, Logic Controller, Programming Guide*).
- **SL2 Post Configuration status:** The parameters with the activated check box are defined by the post configuration file. This information can also be obtained from within a program by testing the system word %SW99 (see *Modicon M221, Logic Controller, Programming Guide*).
- **ETH Post Configuration status:** The parameters with the activated check box are defined by the post configuration file. This information can also be obtained from within a program by testing the system word %SW100 (see *Modicon M221, Logic Controller, Programming Guide*).

Section 6.6

RTC Management

Managing the RTC

Overview

The **RTC Management** window enables you to set the real time clock (RTC) of the logic controller. This is only possible if EcoStruxure Machine Expert - Basic is connected to a logic controller that supports an RTC.

Updating the RTC

Step	Action
1	Select the RTC Management option in the left-hand area of the Commissioning window.
2	If in online mode, the Current controller time is displayed. Choose the mode for setting the logic controller time: <ul style="list-style-type: none">● Manual : This mode displays the date and time and lets you manually choose what date and time to set in the logic controller.● Automatic : This mode sets the time in the logic controller to the current time of the PC on which EcoStruxure Machine Expert - Basic is installed.
3	Click Apply .

Chapter 7

Simulator

What Is in This Chapter?

This chapter contains the following topics:

Topic	Page
Overview of the EcoStruxure Machine Expert - Basic Simulator	264
EcoStruxure Machine Expert - Basic Simulator I/O Manager Window	266
EcoStruxure Machine Expert - Basic Simulator Time Management Window	268
Modifying Values Using EcoStruxure Machine Expert - Basic Simulator	271
How to Use the EcoStruxure Machine Expert - Basic Simulator	275
Launching Simulation in Vijeo-Designer	276

Overview of the EcoStruxure Machine Expert - Basic Simulator

Introduction

EcoStruxure Machine Expert - Basic simulator allows you to:

- Simulate a connection between the PC, the logic controller, and any expansion modules.
- Run and test a program without a logic controller and expansion modules, connected to the PC physically.

The simulator replicates the behavior of the logic controller and is a virtual logic controller that you connect to with EcoStruxure Machine Expert - Basic.

NOTE: Security parameters (*see Modicon M221, Logic Controller, Programming Guide*) are not applied when using the simulator.

Once you launch the simulator, you can connect, run, stop and other associated actions that you would accomplish while connected to a physical logic controller.

NOTE: The simulator supports up to 2 connections; one for EcoStruxure Machine Expert - Basic and other one for data purpose (for example, HMI communication).

Accessing the EcoStruxure Machine Expert - Basic Simulator

Step	Action
1	Ensure that the program is valid. Otherwise, the simulator launch is interrupted with a compilation error detected message that appears on the screen.
2	Launch the simulator by any of the following methods: <ul style="list-style-type: none"> • Click Launch simulator in the commissioning task area. • Press CTRL+B in the Commissioning window. • Click  (launch simulator button) in the EcoStruxure Machine Expert - Basic tool bar.

EcoStruxure Machine Expert - Basic Simulator Windows

EcoStruxure Machine Expert - Basic simulator has the following 2 windows:

- **Simulator time management window**
Lets you control the RTC of the controller in order to simulate the passage of time and its effect on the logical constructs affected by the RTC.
- **Simulator I/O manager window**
Lets you manage the state of inputs/outputs of the controller and the expansion modules.

After the connection between the PC and the virtual logic controller has been successfully established (refer to How to Use the EcoStruxure Machine Expert - Basic Simulator (see page 275)), EcoStruxure Machine Expert - Basic Simulator I/O manager window appears on the screen:

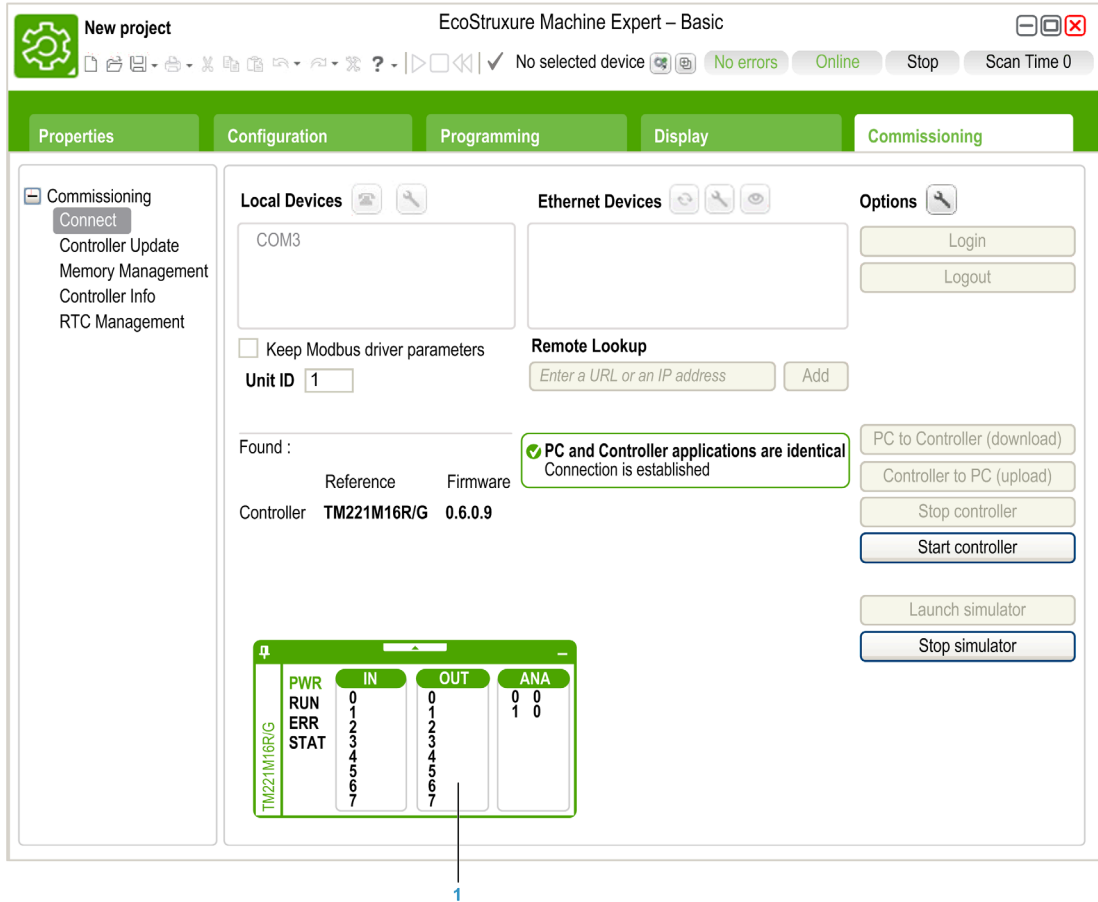

1 Simulator I/O manager window (see page 266)

EcoStruxure Machine Expert - Basic Simulator I/O Manager Window

Overview

Simulator I/O manager window has the following components:

- LED status:
To monitor the LED status of a simulated controller.
- Input/output status:
To control the inputs and outputs when the program is running.

Simulator I/O Manager Window

This graphic shows the simulator I/O manager window:

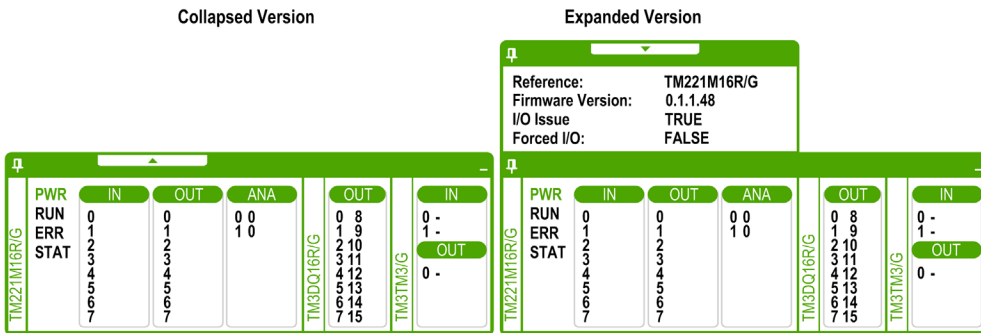

Click the pin symbol on the left-top of this window to pin or unpin the window to the foreground.

Click the minimize symbol on the right-top of this window to minimize the window in taskbar.

LED Status

The PWR, RUN, ERR, and STAT LEDs are simulated in the EcoStruxure Machine Expert - Basic simulator I/O manager window as they would appear on a connected base controller.

The following are the LED states displayed in the simulator I/O manager window of a simulated logic controller:

LED	Status Information
PWR	Indicates whether the simulated logic controller is powered up or not.
RUN	Indicates the RUN state of the simulated logic controller.
ERR	Indicates the ERR state of the simulated logic controller.
STAT	The operation of the STAT LED is defined by the user logic.

Input/Output Status

Simulator I/O manager window lets you monitor and control the I/Os of a controller and expansion module when a program is running.

The inputs and outputs are displayed in a list of numbers. This list depends on the I/Os of the selected controller and expansion module. For example, if your controller has n digital inputs, the number list will display number starting from $0 \dots (n-1)$, where each number corresponds to the digital input at the corresponding input channel.

For a controller, the I/Os displayed are:

- **IN**: Digital inputs.
- **OUT**: Digital outputs.
- **ANA**: Analog inputs.

For an expansion module, the I/Os displayed are:

- **IN**: Digital/analog inputs.
- **OUT**: Digital/analog outputs.

NOTE: The analog I/Os are displayed with their current values on right-hand side of the analog input number.

Digital I/O status is identified by the text color of the I/O numbers:

- Green: I/O is set to 1.
- Black: I/O is set to 0.

Analog I/O status is identified by the value:

- - (hyphen): I/O is not configured.
- Number: Current value of the I/O.

EcoStruxure Machine Expert - Basic Simulator Time Management Window

Overview

Simulator **Time Management** window has the following components:

- Date / Time simulation range for the execution of the program in the simulator:
 - **Beginning** Date and Time
 - **End** Date and Time
 - **Stop at the End** check box (stop the execution of the program when the **End** Date and Time are reached)
- Time control scroll bar:
 - To move the simulation of the passage of time manually forward or back
- Date and Time display:
 - Date and Time of the simulated RTC of the simulator
- Control buttons:
 - To reset, jump back, jump forward, or end the time management associated with the RTC
- Increment bar:
 - To fix the rate of the simulated passage of time relative to real time

Simulator Time Management Window

To display the **Time Management** window:

Step	Action
1	Right-click on the top bar of the Simulator I/O Management window.
2	Choose Time Management .

This graphic presents the simulator **Time Management** window:

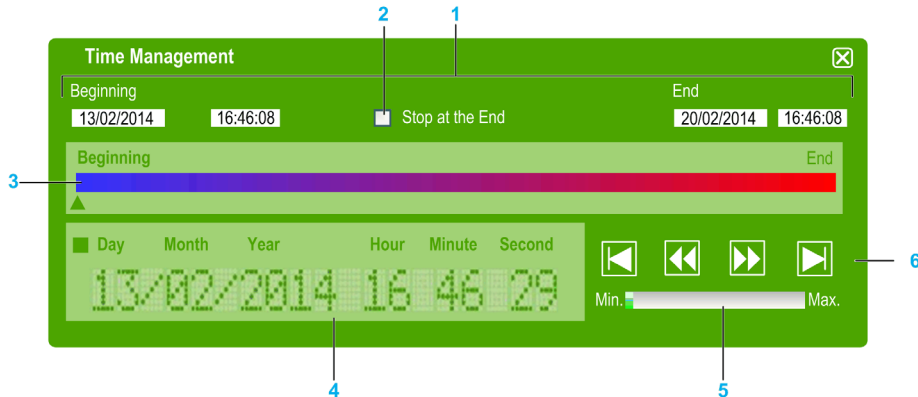

- 1 Date / Time simulation range (Beginning – End)
- 2 Stop at the end (of Date / Time range) check box
- 3 Time control scroll bar
- 4 RTC date and time
- 5 Increment bar
- 6 Elapsed time control buttons

Simulator Date / Time Simulation Range

The simulation range allows you to establish and control the RTC of the simulator. The RTC is set with the **Beginning** date and time fields when you set the simulator into a RUN state. The **End** date and time fields establishes the end of your simulation. If you check the **Stop at the End** check box, the simulator enters a STOP state at the expiration of the simulation range. Otherwise, the simulator will continue to run, as will the RTC, until you manually stop the simulator with EcoStruxure Machine Expert - Basic.

Time Control Scroll Bar

The time control scroll bar allows you to manually manipulate the date and time you have established simulation range. Click and hold the right mouse button while pointing at the arrow below the bar and moving the mouse to the right advances the time and date of the RTC. Doing the same and moving the mouse to the left reverse the time and date of the RTC.

RTC Date and Time





The RTC date and time zone displays the value of the RTC as it relates to the ongoing simulation. The initial time of the RTC is established by the **Beginning** date and time when you place the simulator in a RUN state. Thereafter, the display is updated with the ongoing clocking of the RTC in the simulator. You can alter the RTC either with the time control scroll bar or with the Time elapse speed control buttons.

Increment Bar

The increment bar allows you to establish a relative increment for Jumping forward or back the RTC value when using the elapsed time control buttons. By clicking the bar you can set various increments that are relative to the simulation range you have established.

Elapsed Time Control Buttons

You can use the control buttons to effect the RTC value, and therefore manipulate its affect on your program running in the simulator as follows:

Graphic Element	Command	Description
	Initialize	Allows you to reset the date and time back to that which is set in the Beginning time/date field.
	Jump Forward	Allows you to move forward the time and date from its current value in increments established by the Increment bar.
	Jump Back	Allows you to reverse the time and date from its current value in increments established by the Increment bar.
	End	Allows you to jump the date and time to that which is set in the End time/date field.

Modifying Values Using EcoStruxure Machine Expert - Basic Simulator

Overview

When in online mode, EcoStruxure Machine Expert - Basic simulator I/O manager window allows you to:

- Modify values of the inputs.
- Trace the outputs.

Modifying Values of Digital Inputs

Follow these steps to modify the digital input value, using single-click operation:

Step	Action
1	Click the digital input number in the simulator I/O manager window to change the discrete input value. Result: Text color of the input number changes. Digital input values are identified by the text color: <ul style="list-style-type: none"> • Green: I/O is set to 1. • Black: I/O is set to 0.
2	Click again on the same input number to toggle the value.

Follow these steps for bulk operation of modifying digital input values together:

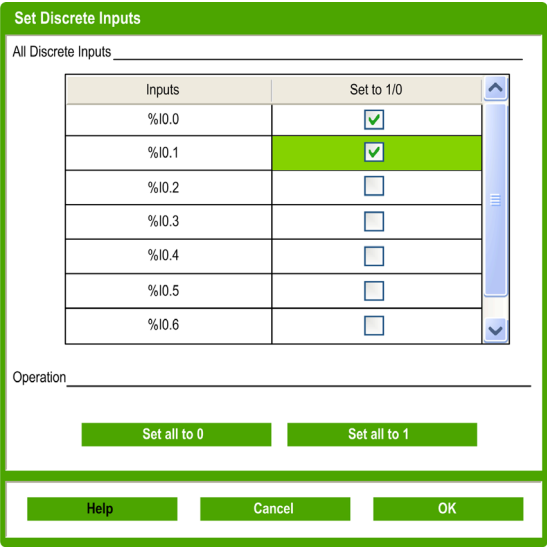
Step	Action																
1	<p>Double-click the digital input number in the simulator I/O manager window, Result: Set Discrete Inputs window listing all digital inputs, appears on the screen:</p>  <p>The screenshot shows the 'Set Discrete Inputs' dialog box. It features a table with the following data:</p> <table border="1"> <thead> <tr> <th>Inputs</th> <th>Set to 1/0</th> </tr> </thead> <tbody> <tr> <td>%I0.0</td> <td><input checked="" type="checkbox"/></td> </tr> <tr> <td>%I0.1</td> <td><input checked="" type="checkbox"/></td> </tr> <tr> <td>%I0.2</td> <td><input type="checkbox"/></td> </tr> <tr> <td>%I0.3</td> <td><input type="checkbox"/></td> </tr> <tr> <td>%I0.4</td> <td><input type="checkbox"/></td> </tr> <tr> <td>%I0.5</td> <td><input type="checkbox"/></td> </tr> <tr> <td>%I0.6</td> <td><input type="checkbox"/></td> </tr> </tbody> </table> <p>Below the table, there are two buttons: 'Set all to 0' and 'Set all to 1'. At the bottom of the dialog are 'Help', 'Cancel', and 'OK' buttons.</p>	Inputs	Set to 1/0	%I0.0	<input checked="" type="checkbox"/>	%I0.1	<input checked="" type="checkbox"/>	%I0.2	<input type="checkbox"/>	%I0.3	<input type="checkbox"/>	%I0.4	<input type="checkbox"/>	%I0.5	<input type="checkbox"/>	%I0.6	<input type="checkbox"/>
Inputs	Set to 1/0																
%I0.0	<input checked="" type="checkbox"/>																
%I0.1	<input checked="" type="checkbox"/>																
%I0.2	<input type="checkbox"/>																
%I0.3	<input type="checkbox"/>																
%I0.4	<input type="checkbox"/>																
%I0.5	<input type="checkbox"/>																
%I0.6	<input type="checkbox"/>																

Step	Action
2	In the Operation area of the Set Discrete Inputs window, click: <ul style="list-style-type: none"> ● Set all to 0: To set the value of all inputs to 0. ● Set all to 1: To set the value of all inputs to 1. Result: If the checkbox is selected, input value is set to 1. If not selected, input value is set 0.
3	Alternatively, in the All Discrete Inputs area of the Set Discrete Inputs window, click the checkbox corresponding to the input to modify the values individually.
4	Click OK to save the changes and exit from the Set Discrete Inputs window.

Modifying I/O Values of Analog Inputs

Follow these steps for modifying analog input values:

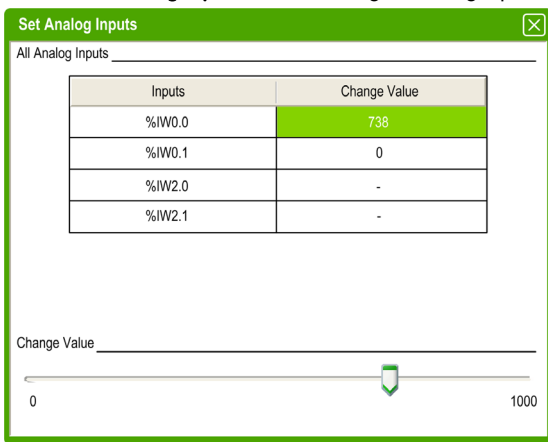
Step	Action
1	Double-click the analog input number in the simulator I/O manager window, Result: Set Analog Inputs window listing all analog inputs, appears on the screen: 
2	In the All Analog Inputs area of the Set Analog Inputs window, double-click the value field in the Change Value column corresponding to the input to be modified.
3	Enter the value in the range 0...1023 and press ENTER.
4	Alternatively, in the Set Analog Inputs window, select an input from the Inputs list and move the slider in the Change Value area to adjust the input value between 0...1023. When you move the slider from left to right, the value increases and vice versa.
5	Click OK to save the changes and exit from the Set Analog Inputs window.

Tracing the Outputs

Output values depend on the program; therefore you cannot modify the values but EcoStruxure Machine Expert - Basic simulator offers you to trace the digital and analog outputs.

Follow these steps for modifying analog input values:

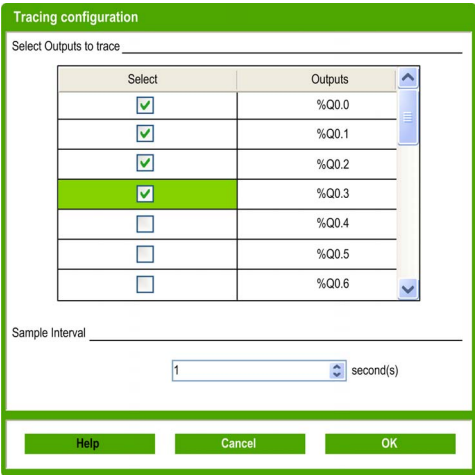
Step	Action
1	<p>Double-click the output number in the simulator I/O manager window, Result: Tracing window appears on the screen.</p> 
2	<p>Click Configure button to select the outputs to trace. Result: Tracing Configuration window appears on the screen.</p> 

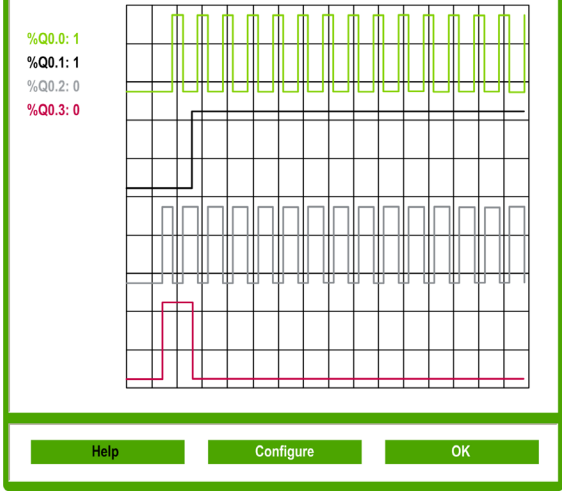
Step	Action
3	In the Select checkbox column, click the checkboxes corresponding to the outputs to trace.
4	Select the Sample Interval from the drop-down menu to set the sample time interval for output tracing: <ul style="list-style-type: none"> ● 1 second ● 5 seconds ● 10 seconds ● 20 seconds
5	Click OK to save and exit from the Tracing Configuration window. Result: Selected outputs are added to the Tracing window that displays tracing of the outputs with simulated values: <div data-bbox="275 475 838 1031" style="border: 2px solid green; padding: 10px; margin: 10px 0;"> <p style="margin: 0;">Tracing</p> <p style="margin: 0;">Discrete Outputs</p>  </div>
6	Click OK to exit from the Tracing window.

How to Use the EcoStruxure Machine Expert - Basic Simulator

Procedure

Follow these steps to run the EcoStruxure Machine Expert - Basic Simulator to test your program:

Step	Action
1	Ensure that you have a valid program by checking the status message in the status area (for more information, refer to Status Area (see page 47)). The program status should be No errors . You can also run EcoStruxure Machine Expert - Basic simulator when the program status is Advice .
2	Launch the simulator (refer to Accessing the Simulator (see page 264)).
3	Run the controller. In the Commissioning window, select Connect in the commissioning tree and then click Run controller button in the commissioning task area.
4	Command your program using the simulator main window (refer to Control Buttons (see page 269)).
5	Check the LED status in the simulator main window (refer to LED Display (see page 267)).
6	Check the status of the inputs/outputs in the simulator I/O manager window (refer to Input/Output Status (see page 267)).
7	Check the LED status in the simulator I/O manager window (refer to LED Status (see page 266)).
8	Modify the I/O values as required (refer to Modifying Values Using the Simulator (see page 271)).
9	Trace the outputs as required (refer to Tracing the Outputs (see page 273)).
10	Stop the controller. In the Commissioning window, select Connect in the commissioning tree and then click Stop controller button in the commissioning task area.
11	Stop the simulator. In the Commissioning window, select Connect in the commissioning tree and then click Stop controller button in the commissioning task area or press CTRL+W to exit from the simulator.

Launching Simulation in Vijeo-Designer

Procedure

Prior to launching the HMI simulation in Vijeo-Designer, first start the logic controller simulator in EcoStruxure Machine Expert - Basic (*see page 264*).

Follow these steps to launch the simulation in Vijeo-Designer:

Step	Action
1	Start Vijeo-Designer.
2	Open the Vijeo-Designer project that contains the symbols from an EcoStruxure Machine Expert - Basic project. NOTE: If the Vijeo-Designer project does not exist, create a project in Vijeo-Designer and share the symbols with the EcoStruxure Machine Expert - Basic project. For more information, refer to Sharing Symbols Between an EcoStruxure Machine Expert - Basic Project and an Vijeo-Designer Project (<i>see page 163</i>).
3	Click the Project tab in the Navigator window, right-click the equipment node under the IO Manager node, and select Configuration . Result: The Equipment Configuration window opens.
4	Enter the IP Address and click OK . NOTE: The IP address must be a local host address or local address of your PC. For example, 127.0.0.1
5	Start Device Simulation Tool .
6	Click the Variables tab and select the check boxes of the variables to include in the simulation. NOTE: If the View All icon is selected, all variables selected in the Variables tab are displayed in the Simulation tab.
7	Click the Simulation tab.
8	Select a variable, select an operation for the variable, and then select the Active check box. NOTE: Only one simulation operation can be applied to any given variable at a time.
9	Define the parameters of the variable simulation operation.
10	Click the Simulation icon to start the simulation.
11	Change the variable values as required during the simulation: <ul style="list-style-type: none"> ● For a slider operation, you can change the value by moving the slider, moving the wheel on your mouse, or typing the arrow keys on the keyboard. ● For a toggle operation, click Set or Reset to write the corresponding string to the variable.
12	Click the Simulation icon again to stop the simulation.
13	Press CTRL+Z to exit the Device Simulation Tool .

Chapter 8

Saving Projects and Closing EcoStruxure Machine Expert - Basic

What Is in This Chapter?

This chapter contains the following topics:

Topic	Page
Saving a Project	278
Saving a Project As a Template	279
Closing EcoStruxure Machine Expert - Basic	280

Saving a Project

Overview

EcoStruxure Machine Expert - Basic projects can be saved as files to the local PC. This file has the extension *.smbp and contains:

- The source code of the program contained on the **Programming** tab
- The current hardware configuration contained on the **Configuration** tab
- Settings and preferences set in the EcoStruxure Machine Expert - Basic project.

Saving the Project

Step	Action
1	Click Save  on the toolbar, or press <code>Ctrl-S</code>
2	If this is the first time you have saved the project, browse and select the folder in which to store the project file.
3	Type the name of the project file and click Save .

Saving the Project with a Different Name

Step	Action
1	Click the menu arrow next to the Save button  on the toolbar and choose Save as .
2	Browse and select the folder in which to store the project file.
3	Type the new name of the project file and click Save .

Saving a Project As a Template

Overview

EcoStruxure Machine Expert - Basic projects can be saved as templates. The project is then listed on the **Templates** tab of the **Start Menu**. You can then use the project as the starting point for new projects.

Saving a Project as a Template

Step	Action
1	Click the menu arrow next to the Save button  on the toolbar and choose Save as template . By default, templates are saved to the folder: C:\Users\Public\EcoStruxure Machine Expert - Basic\Examples.
2	Type the name of the project.
3	Choose Sample Project Files (*.smbe) as the file Type and click Save .

Closing EcoStruxure Machine Expert - Basic

Overview

To exit EcoStruxure Machine Expert - Basic, click the **Close** button in the top right-hand corner of the EcoStruxure Machine Expert - Basic window.

You can also click **Exit** on the **Start Menu**.

Appendices



What Is in This Appendix?

The appendix contains the following chapters:

Chapter	Chapter Name	Page
A	Converting Twido Projects to EcoStruxure Machine Expert - Basic	283
B	EcoStruxure Machine Expert - Basic Keyboard Shortcuts	293

Appendix A

Converting Twido Projects to EcoStruxure Machine Expert - Basic

Converting Twido Projects to EcoStruxure Machine Expert - Basic

Overview

When you open a TwidoSoft or TwidoSuite (*see page 37*) project, it is automatically converted to an EcoStruxure Machine Expert - Basic project associated with a M221 logic controller reference. After the association is made, you can change the M221 Logic Controller reference (*see page 62*). A conversion report is generated listing any aspects of the TwidoSoft or TwidoSuite project that could not be automatically converted to the equivalent EcoStruxure Machine Expert - Basic functionality.

The following provides additional conversion information.

WARNING

UNINTENDED EQUIPMENT OPERATION

- Always verify that your application program operates as it did prior to the conversion, having all the correct configurations, parameters, parameter values, functions, and function blocks as required.
- Modify the application as necessary such that it conforms to its previous operation.
- Thoroughly test and validate the newly compiled version prior to putting your application into service.

Failure to follow these instructions can result in death, serious injury, or equipment damage.

Twido Program Types Requiring Manual Adaption

This table lists Twido project types that use functionality with no direct equivalent on the M221 Logic Controller and provides some advice on converting these projects for EcoStruxure Machine Expert - Basic:

Twido Program Type	Solution	Description
Program using CANopen	Consider converting the program to use the Ethernet network.	Refer to the M221_with_LXM32_Modbus_TCP and M221_with_ILx2T_Modbus_TCP templates (perform a search in the Templates window <i>(see page 38)</i>).
Program using Twido Macro Comm	The Twido code is automatically converted to use EXCH instructions. Consider modifying the program to use Communication function blocks <i>(see EcoStruxure Machine Expert - Basic, Generic Functions Library Guide)</i> .	Refer to the xSample_twido_macro_COMM_Conversion project template and associated documentation (perform a search in the Templates window <i>(see page 38)</i>) to help you modify the converted program to use Communication function blocks.
Program using Twido drive macros	Parts of the Twido code cannot be automatically converted to Ladder language code.	Refer to the xSample_ATV Modbus SL_M221 or xSample_Twido_Macro_Drive_Conversion project templates to help you adapt drive management functionality.
Twido Extreme TWDLEDCK1 project	This type of project cannot be automatically converted.	To retrieve a part of the program: <ul style="list-style-type: none"> ● Change the controller in the TwidoSuite program from TWDLEDCK1 to a different Twido controller ● Convert the updated project
Program using the Remote Link Protocol	Consider modifying the program to use the following M221 Logic Controller features: <ul style="list-style-type: none"> ● Modbus TCP mapping on the Ethernet network ● Modbus serial protocol using Communication function blocks <i>(see EcoStruxure Machine Expert - Basic, Generic Functions Library Guide)</i> 	The Remote Link protocol allows the use of a Twido controller as a remote I/O module on a serial line.

Messages Listed in the Conversion Report

The following table provides additional information for specific message IDs referenced in the conversion report:

Message ID	Message	Description/Solution
Error Messages		
TC-001	Impossible to load the Twido project	The Twido project file could not be opened in EcoStruxure Machine Expert - Basic.
TC-002	The folder containing Twido information (with the same name and location as the .xpr file) was not found	The specified folder could not be found.
TC-003	Twido File <filename> is not in the correct format	The Twido project is not in the correct format, nothing is converted.
TC-004	Twido File <filename> has an unexpected format	The Twido project is incomplete, nothing is converted.
TC-005	Device <device> is not supported	The Twido reference <device> is not supported. Nothing is converted.
TC-006	CANopen macro has not been translated into IL	As the M221 Logic Controller does not support CANopen, Twido CANopen macros are not supported.
Advisory Messages		
TC-101	The Serial Line 2 Physical medium has been changed to RS485	On TM221M*** references, Serial Line 2 cannot be configured in RS232. Consider configuring your external device in RS485 instead. Alternatively, you can add an external RS232/RS485 adapter, replace the logic controller with a TM221C*** reference, or add a TMC2 cartridge that supports RS232 to the controller.
TC-102	The Remote Link configuration on the Serial Line has been replaced by the Modbus protocol.	The Remote Link protocol is not supported on the M221 Logic Controller. Other solutions are possible, for example, using Communication function blocks on Modbus, or a Modbus mapping table if using an M221 Logic Controller that has Ethernet. Also refer to the information provided in Twido Program Types Requiring Manual Adaption (see page 284)
TC-103	TWDXCPODC expansion is not supported in EcoStruxure Machine Expert - Basic. It has not been imported.	TWDXCPODC is an expansion module for a display that is not supported in EcoStruxure Machine Expert - Basic. For the M221 Logic Controller, you can use the TMH2GDB Remote Graphic Display which provides an operator interface application.

Message ID	Message	Description/Solution
TC-104	TWDXCPODM expansion is not supported in EcoStruxure Machine Expert - Basic. It has not been imported.	TWDXCPODM is an expansion module for a display that is not supported in EcoStruxure Machine Expert - Basic. For the M221 Logic Controller, you can use the TMH2GDB Remote Graphic Display which provides an operator interface application.
TC-105	New logic controller <reference> does not support Pulse (PLS) or Pulse Width Modulation (PWM)	The Twido Compact Base 40 I/O, 240 Vac Controller had 2 transistor fast outputs. In the M221 Logic Controller range, only 24 Vdc-powered controllers have transistor outputs. The M221 Vac-powered controllers have only relay outputs. If replacing controllers, choose a M221 Logic Controller with a 24 Vdc power supply.
TC-106	CANopen communication expansion is not supported in EcoStruxure Machine Expert - Basic. It has not been imported.	The M221 Logic Controller does not support CANopen. If you need CANopen, use a Modicon M241 Logic Controller. Alternatively, replace the communication bus with Modbus on serial line or Modbus TCP on Ethernet.
TC-107	AS-Interface master expansion is not supported in EcoStruxure Machine Expert - Basic. It has not been imported.	The M221 Logic Controller does not provide an AS-Interface Master module. Consider using an Ethernet-AS Interface gateway, or use remote I/O using the Modbus serial, Modbus TCP, or EtherNet/IP protocols.
TC-108	TM200 HSC expansion is not supported in EcoStruxure Machine Expert - Basic. It has not been imported.	The M221 Logic Controller has 4 fast inputs that can be associated with High Speed Counters.
TC-109	TWD PTO expansion is not supported in EcoStruxure Machine Expert - Basic. It has not been imported.	The M221 Logic Controller references without relay outputs have 2 or 4 fast outputs that can be associated with Pulse Train Outputs.
TC-110	TM2 VCM expansion is not supported in EcoStruxure Machine Expert - Basic. It has not been imported.	TM2 VCM expansion modules are not supported in EcoStruxure Machine Expert - Basic.
TC-111	Timer 3 "Adjustable" parameter is not supported in EcoStruxure Machine Expert - Basic. It has been forced to True	In EcoStruxure Machine Expert - Basic function blocks, this parameter is not supported.
TC-112	%QA ASi outputs are not supported in EcoStruxure Machine Expert - Basic.	These addresses were reserved for the management of AS-Interface remote I/Os. As with the AS-Interface Master module, these addresses are not supported on the M221 Logic Controller.

Message ID	Message	Description/Solution
TC-113	The Auto-tune on PID has changed; the new parameter AT Trigger of the PID Autotune (AT) tab has been added and configured and the parameter 'Output setpoint' has been ignored.	In EcoStruxure Machine Expert - Basic, configure PID auto-tuning.
TC-114	The input used by HSCn (in Twido: VFCn) changed from <input1> to <input2>.	Verify whether your program uses the input assigned.
TC-115	The inputs used by HSCn <input1> and <input2> are inverted relative to Twido VFCn.	HSC inputs <input1> and <input2> on Twido VFC controllers are inverted in EcoStruxure Machine Expert - Basic; invert the inputs in the application.
TC-116	The Free POU <x> is already assigned to <y>. The <z> event cannot use this Free POU.	Assign the Free POU to a different event.
TC-117	<x> Twido object has been moved to <y> on new controllers. You must update your program to maintain consistency.	The object has been converted to an EcoStruxure Machine Expert - Basic object with similar functionality. <y> can be a system bit, system word, or a different object type such as %IWS.
TC-118	<x> Twido object has been modified on new controllers. You must verify if your controller is still consistent.	The object has been converted, but its functionality in EcoStruxure Machine Expert - Basic may be different. Refer to the online help for assistance in updating your program.
TC-119	<x> Twido object is no longer supported on new controllers. You must update your program using new functionalities.	The object has no equivalent in EcoStruxure Machine Expert - Basic. Refer to the online help for assistance in updating your program.
TC-120	The source controller is powered by 24 Vdc but the target controller <reference> is powered by 100...240 Vac.	The converted M221 Logic Controller does not have the same power supply, but there is no impact on the application.
TC-121	The source controller <reference1> with transistor and relay outputs has been converted to <reference2> with transistor outputs only.	The converted M221 Logic Controller does not have the same output types. The conversion allows the application to remain unchanged.
TC-122	Invalid syntax for symbol <x> associated with <y>.	Correct the syntax of the specified symbol.
TC-123	Symbol '<x>' associated with <y> is a reserved word and has been converted to <z>.	EcoStruxure Machine Expert - Basic has new instructions compared to TwidoSuite/TwidoSoft. Reserved words are converted to <z>.

Message ID	Message	Description/Solution
TC-124	<w> time base configured in <x> has been converted to <y>. You may have to adjust accordingly the preset in the configuration and <w>. <z> in the application.	This message occurs when converting an application using PLS or PWM. On Twido, the hardware time bases are 0.142 ms and 0.57 ms. On the M221 Logic Controller, the hardware time bases are 0.1 ms and 1 ms, respectively. For the PLS and PWM function blocks, the period of the generated signal is the time base multiplied by the preset value (PLS.P, PLS.PD, or PWM.P). Preset values (.P or .PD) may have to be adjusted in both the configuration and the program.
TC-125	<x> configured in <y> has been converted in <z>.	The M221 Logic Controller does not support HSC in "down counting" mode. These configurations are converted to "simple counting" mode (that is, up counting) in EcoStruxure Machine Expert - Basic.
TC-126	Threshold values for <x> have been modified as they must not be equal to each other.	In EcoStruxure Machine Expert - Basic, it is not possible to have identical threshold values. If the Twido application does not use the thresholds (no associated event or reflex configured), the values are modified to avoid configuration errors.
TC-127	Threshold values for <x> are equal and will result in a configuration error.	In EcoStruxure Machine Expert - Basic, it is not possible to have identical threshold values. If the Twido application uses the thresholds, nothing is changed, resulting in a configuration error. Modify the application to correct the error.
TC-128	<x> is configured as both Run/Stop and event trigger in Twido project, creating a conflict in EcoStruxure Machine Expert - Basic; the Run/Stop feature has been deconfigured.	In EcoStruxure Machine Expert - Basic, it is not possible to have the same input configured in 2 different functions at the same time.
TC-129	An Ethernet module has been detected on a Twido reference with embedded Ethernet port. The Ethernet module configuration will be ignored.	In EcoStruxure Machine Expert - Basic, it is not possible to have two Ethernet links.
TC-130	A Twido macro cannot be called from a subroutine. The macro called from SRn rung <x> has not been converted.	In EcoStruxure Machine Expert - Basic, it is not possible to call a macro from a subroutine.
TC-131	Unable to convert all event priorities. Manual adjustment is required.	The conversion process was not able to set all event priorities.
TC-132	Unable to convert macro <macro>: maximum number of subroutines are used.	The Twido project already uses the maximum number of subroutines, which have been converted to Free POU's. The macro conversion process may require additional Free POU's.

Message ID	Message	Description/Solution
TC-133	Passwords from Twido applications must be entered in uppercases.	The Twido password was saved in uppercase letters by TwidoSuite or TwidoSoft.
Information Messages		
TC-201	Controller <reference1> has been replaced by <reference2>.	EcoStruxure Machine Expert - Basic has made a default choice of replacement controller. If it does not match the characteristics needed, replace the controller with a different reference.
TC-202	Module <reference1> has been replaced by <reference2>.	EcoStruxure Machine Expert - Basic converts TM2 modules to equivalent TM3 modules.
TC-203	An Ethernet module has been detected. The controller has been converted to an equivalent reference with an Ethernet port.	If a 499TWD01100 module is configured in TwidoSuite, the conversion selects a M221 Logic Controller reference with an embedded Ethernet port.
TC-204	A NAC serial line option was detected. A serial line cartridge has been added to the configuration.	The serial line cartridge TMC2SL1 replaces one of the 3 TWDNAC serial adapters of Compact Twido. Verify the configuration and the cabling.
TC-205	A NOZ serial line option was detected. Its configuration has been set in SL2.	The serial line cartridge TMC2SL1 replaces one of the 3 TWDNOZ serial expansion modules of Modular Twido. Verify the configuration and the cabling.
TC-206	<device> has been changed to generic modem.	The TD-33/V90 modem is not supported in EcoStruxure Machine Expert - Basic.
TC-207	<device> which was configured on SL2 has been removed; only SL1 modems are authorized.	It is not possible to configure a modem on serial line SL2 on the M221 Logic Controller. Add the modem on serial line SL1.
TC-208	The functional level of the project has been set to <x>.	Verify that the specified functional level corresponds to the feature set of the logic controllers in your configuration.
TC-209	The priority of <x> has been converted from <y> to <z>.	Verify the priority level assigned to the event.
TC-210	Macro <x> in POU <y> - Rung <z> has been converted to equivalent code in POU <a> - Rung .	Verify the functionality of the converted code.
TC-211	Macro <x> in POU <y> - Rung <z> has been converted to equivalent code in Free POU <a>.	Verify the functionality of the converted code in the Free POU.

System Bits

This table presents Twido system bits that have either no equivalent on the M221 Logic Controller, or a different purpose:

Twido System Bit	Description	M221 Logic Controller System Bit	Description
%S8	Wiring test	Removed	Not implemented on the M221 Logic Controller
%S24	Operations Display can be frozen	Removed	Replaced by the Remote Graphic Display
%S25	Choosing a display mode on the operator display	Removed	Replaced by the Remote Graphic Display
%S26	Choosing a signed or unsigned value on the display	Removed	Replaced by the Remote Graphic Display
%S31	Event mask	Removed	Not implemented on the M221 Logic Controller
%S66	BAT LED display enable/disable on some Brick 40	Removed	Not implemented on the M221 Logic Controller
%S69	User STAT LED display	Removed	There is no user STAT LED on the M221 Logic Controller
%S95	Restore memory words	Moved to %S94	Set this bit to 1 to restore the data saved in non-volatile memory
%S97	Save %MW OK	Moved to %S92	%MW variables saved in non-volatile memory
%S100	TwidoSuite communications cable connection	Removed	The M221 Logic Controller uses a USB cable
%S110	Remote link exchanges	Modified	Resets the Modbus Serial IOScanner on Serial Line 1
%S111	Single remote link exchange	Modified	Resets the Modbus Serial IOScanner on Serial Line 2
%S112	Remote link connection	Modified	Resets the Modbus TCP IOScanner on Ethernet.
%S113	Remote link configuration/operation	Modified	Suspends the Modbus Serial IOScanner on Serial Line 1
%S118	Remote I/O Error	Removed	The Remote Link feature is not implemented on the M221 Logic Controller
%S120	Input PWM0 overflow (%IW0.7) (Twido Extreme)	Removed	No Input PWM on the M221 Logic Controller
%S121	Input PWM1 overflow (%IW0.8) (Twido Extreme)	Removed	No Input PWM on the M221 Logic Controller

For more details, refer to System Bits %S.

System Words

This table presents Twido system words that have no equivalent on the M221 Logic Controller, or a different purpose:

Twido System Word	Description	M221 Logic Controller System Word	Description
%SW6	Controller status	Modified	Controller state
%SW7	Controller state	Modified	Controller status
%SW20...%SW27	Provides status for CANopen slave modules	Removed	The CANopen bus is not available on the M221 Logic Controller
%SW49...%SW53	RTC Functions: words containing the date and time values (in BCD format)	Modified	RTC functions: words containing date and time values (in BCD).
%SW58	Displays code giving cause of last stop	Modified	Displays code giving cause of last stop.
%SW59	Adjust current date	Modified	Adjust current date.
%SW60	RTC correction value	Removed	No RTC correction is available.
%SW67	Function and type of controller	Modified	Function and type of controller.
%SW68	Elements displayed on the 2-line operator display	Removed	There is no embedded display on the M221 Logic Controller, replaced by the Remote Graphic Display.
%SW69	Elements displayed on the 2-line operator display	Removed	There is no embedded display on the M221 Logic Controller, replaced by the Remote Graphic Display.
%SW73	AS-Interface System State	Removed	The ASI bus is not available on the M221 Logic Controller.
%SW74	AS-Interface System State	Removed	The ASI bus is not available on the M221 Logic Controller.
%SW80	Base I/O Status	Modified	Embedded analog input status
%SW81...%SW87	I/O Expansion Module 1 to 7 status	Moved to %IWS, %QWS	System objects for analog input or analog output status
%SW96	Command and/or diagnostics for save/restore function of application program and %MW	Modified	Diagnostics for save/restore function of program and %MW (refer to Persistent Variables (<i>see Modicon M221, Logic Controller, Programming Guide</i>) for details)

Twido System Word	Description	M221 Logic Controller System Word	Description
%SW96:X0	Specifies memory words must be saved to non-volatile memory	%S93	%SW96:X0 cannot be written to on the M221 Logic Controller; replace %SW96:X0 by %S93 in your program. Replace system bits %S95 and %S97 with %S94 and %S92 respectively. Replace system word %SW97 with %SW48. Verify the use of other bits of system word %SW96.
%SW97	Command or diagnostics for save/restore function	Moved to %SW148	Number of persistent variables (Maximum 2000 variables)
%SW111	Remote link status	Removed	The Remote Link feature is not implemented on the M221 Logic Controller.
%SW112	Remote Link configuration/operation error code	Removed	The Remote Link feature is not implemented on the M221 Logic Controller.
%SW113	Remote link configuration	Removed	The Remote Link feature is not implemented on the M221 Logic Controller.

For more details, refer to System Words %SW (see *Modicon M221, Logic Controller, Programming Guide*).

Appendix B

EcoStruxure Machine Expert - Basic Keyboard Shortcuts

EcoStruxure Machine Expert - Basic Keyboard Shortcuts

Keyboard Shortcuts List

Modifier	Key	Command	View	Condition
CTRL	C	Copy	Textbox	–
CTRL	V	Paste	Textbox	–
CTRL	X	Cut	Textbox	–
ALT	Left	Go to previous tab	All	–
ALT	Right	Go to following tab	All	–
	F1	Show help or contextual help	All	Selection in System Settings → General
SHIFT	F1			
ALT	F4	Exit EcoStruxure Machine Expert - Basic	All	–
CTRL	B	Launch simulator	All	–
CTRL	G	Login	All	–
CTRL	H	Logout	All	–
CTRL	L	Stop controller	All	–
CTRL	M	Run controller	All	–
CTRL	N	New project	All	–
CTRL	O	Open project	All	–
CTRL	P	Print project report	All	–
CTRL	Q	Exit EcoStruxure Machine Expert - Basic	All	–
CTRL	S	Save project	All	–
CTRL	W	Stop simulator	All	–
CTRL	J	Download	Commissioning	–
CTRL	K	Upload	Commissioning	–
	ALT	Show Ladder shortcuts	Programming	–
	Del	Delete	Programming	items are selected
CTRL	D	Convert all rungs in program to Ladder	Programming	–

Modifier	Key	Command	View	Condition
CTRL+ALT	D	Convert all rungs in program to IL	Programming	–
CTRL	F	Search	Programming	–
CTRL	I	Insert a new rung before the selected rung	Programming	–
CTRL	Y	Redo	Programming	–
CTRL	Z	Undo	Programming	–
CTRL	Arrow key	Draw line	Ladder rung	Drawing tool selected
CTRL	Arrow key	Erase line	Ladder rung	Erasing tool selected
CTRL	Arrow key	Select/unselect next ladder cell (cell by cell)	Ladder rung	Selection tool selected
SHIFT	Arrow key	Select/unselect next ladder cells (select by area)	Ladder rung	Selection tool selected
	ESC	Reset pointer to selection tool	Ladder rung	Selected tool is not draw wire or erase wire, no items are being dragged, no popup is opened
	ESC	Cancel the pending line	Ladder rung	Drawing in progress
	ESC	Cancel the erasing line	Ladder rung	Erasing in progress
	ESC	Cancel move selected item(s) (restore initial position)	Ladder rung	Ladder items are being dragged
	ESC	Close suggestion's list	Ladder rung	A suggestions list is opened (like the available descriptors for a contact)
	ESC	Close menu item of ladder toolbar	Ladder rung	A menu of the ladder toolbar is opened (like function blocks)
	ENTER	Start/stop moving ladder elements	Ladder rung	At least one selected cell
	Arrow key	Move floating cell	Ladder rung	Moving cell started
	Arrow key	Change current cell	Ladder rung	By default
	F5	Open contact	Ladder rung	Asian set 1 ladder toolbar
	F6	Open branch	Ladder rung	Asian set 1 ladder toolbar
SHIFT	F5	Close contact	Ladder rung	Asian set 1 ladder toolbar
SHIFT	F6	Close branch	Ladder rung	Asian set 1 ladder toolbar
	F7	Coil	Ladder rung	Asian set 1 ladder toolbar
CTRL	F7	Negated coil	Ladder rung	Asian set 1 ladder toolbar
CTRL	F5	Set coil	Ladder rung	Asian set 1 ladder toolbar

Modifier	Key	Command	View	Condition
CTRL	F6	Reset coil	Ladder rung	Asian set 1 ladder toolbar
	F8	Application instruction	Ladder rung	Asian set 1 ladder toolbar
	F9	Draw horizontal line	Ladder rung	Asian set 1 ladder toolbar
	F10	Draw vertical line	Ladder rung	Asian set 1 ladder toolbar
CTRL	F9	Delete horizontal line	Ladder rung	Asian set 1 ladder toolbar
CTRL	F10	Delete vertical line	Ladder rung	Asian set 1 ladder toolbar
SHIFT	F7	Rising pulse open contact	Ladder rung	Asian set 1 ladder toolbar
SHIFT	F8	Falling pulse open contact	Ladder rung	Asian set 1 ladder toolbar
ALT	F7	Rising pulse open branch	Ladder rung	Asian set 1 ladder toolbar
ALT	F8	Falling pulse open branch	Ladder rung	Asian set 1 ladder toolbar
CTRL+SHIFT	O	Comparison block	Ladder rung	Asian set 1 ladder toolbar
	X	XOR blocks	Ladder rung	Asian set 1 ladder toolbar
	F	Function blocks	Ladder rung	Asian set 1 ladder toolbar
	A	Activate step	Ladder rung	Asian set 1 ladder toolbar
	D	Deactivate step	Ladder rung	Asian set 1 ladder toolbar
CTRL+ALT	F10	Reverse operation results	Ladder rung	Asian set 1 ladder toolbar
	O	Other Ladder items	Ladder rung	Asian set 1 ladder toolbar
ALT	F10	Free-drawn line	Ladder rung	Asian set 1 ladder toolbar
ALT	F9	Delete free-drawn line	Ladder rung	Asian set 1 ladder toolbar
	C	New contact	Ladder rung	Asian set 2 ladder toolbar
	/	New close contact	Ladder rung	Asian set 2 ladder toolbar
	W	New contact OR	Ladder rung	Asian set 2 ladder toolbar
	X	New close contact OR	Ladder rung	Asian set 2 ladder toolbar
CTRL+SHIFT	F4	Rising edge	Ladder rung	Asian set 2 ladder toolbar
CTRL+SHIFT	F5	Falling edge	Ladder rung	Asian set 2 ladder toolbar
CTRL+SHIFT	O	Comparison block	Ladder rung	Asian set 2 ladder toolbar
ALT	X	XOR blocks	Ladder rung	Asian set 2 ladder toolbar
	F10	New vertical line	Ladder rung	Asian set 2 ladder toolbar
ALT	L	New horizontal line	Ladder rung	Asian set 2 ladder toolbar
	O	New coil	Ladder rung	Asian set 2 ladder toolbar
	Q	New close coil	Ladder rung	Asian set 2 ladder toolbar
CTRL	F9	Set coil	Ladder rung	Asian set 2 ladder toolbar
CTRL+SHIFT	F9	Reset coil	Ladder rung	Asian set 2 ladder toolbar
	A	Activate step	Ladder rung	Asian set 2 ladder toolbar

Modifier	Key	Command	View	Condition
	D	Deactivate step	Ladder rung	Asian set 2 ladder toolbar
	I	New instruction	Ladder rung	Asian set 2 ladder toolbar
	F	New function block	Ladder rung	Asian set 2 ladder toolbar
ALT	O	Other Ladder items	Ladder rung	Asian set 2 ladder toolbar
	F2	Deactivate branching mode	Ladder rung	European or American ladder toolbar
SHIFT	F2	Activate branching mode	Ladder rung	European or American ladder toolbar
SHIFT	F3	Normally open contact	Ladder rung	European ladder toolbar
SHIFT	F4	Normally close contact	Ladder rung	European ladder toolbar
CTRL+SHIFT	F4	Rising edge	Ladder rung	European ladder toolbar
CTRL+SHIFT	F5	Falling edge	Ladder rung	European ladder toolbar
CTRL+SHIFT	6	Operation block	Ladder rung	European ladder toolbar
CTRL+SHIFT	O	Comparison block	Ladder rung	European ladder toolbar
	X	XOR blocks	Ladder rung	European ladder toolbar
SHIFT	F7	Assignment	Ladder rung	European ladder toolbar
CTRL+SHIFT	F9	Negated coil	Ladder rung	European ladder toolbar
	F9	Set coil	Ladder rung	European ladder toolbar
SHIFT	F9	Reset coil	Ladder rung	European ladder toolbar
	A	Activate step	Ladder rung	European ladder toolbar
	D	Deactivate step	Ladder rung	European ladder toolbar
SHIFT	F5	Function block	Ladder rung	European ladder toolbar
CTRL+SHIFT	F6	Operation block	Ladder rung	European ladder toolbar
	F3	Line	Ladder rung	European ladder toolbar
	F3	Draw wire line	Ladder rung	European ladder toolbar
	F4	Erase wire line	Ladder rung	European ladder toolbar
	O	Other Ladder items	Ladder rung	European ladder toolbar
SHIFT	F2	Activate branching mode	Ladder rung	EcoStruxure Machine Expert - Basic toolbar
	F2	Deactivate branching mode	Ladder rung	EcoStruxure Machine Expert - Basic toolbar
	F3	Draw wire line	Ladder rung	EcoStruxure Machine Expert - Basic toolbar
SHIFT	F3	Erase wire line	Ladder rung	EcoStruxure Machine Expert - Basic toolbar

Modifier	Key	Command	View	Condition
	F4	Normal contact	Ladder rung	EcoStruxure Machine Expert - Basic toolbar
SHIFT	F4	Negated contact	Ladder rung	EcoStruxure Machine Expert - Basic toolbar
CTRL	F9	Coil	Ladder rung	EcoStruxure Machine Expert - Basic toolbar
CTRL+SHIFT	F9	Negative coil	Ladder rung	EcoStruxure Machine Expert - Basic toolbar
	F9	Set Coil	Ladder rung	EcoStruxure Machine Expert - Basic toolbar
SHIFT	F9	Reset Coil	Ladder rung	EcoStruxure Machine Expert - Basic toolbar
CTRL+SHIFT	F4	Rising edge	Ladder rung	EcoStruxure Machine Expert - Basic toolbar
CTRL+SHIFT	F5	Falling edge	Ladder rung	EcoStruxure Machine Expert - Basic toolbar
CTRL+SHIFT	{6, 7}	Operation Block	Ladder rung	EcoStruxure Machine Expert - Basic toolbar
CTRL+SHIFT	{O, P}	Comparison Block	Ladder rung	EcoStruxure Machine Expert - Basic toolbar
X or ALT+X		XOR blocks	Ladder rung	EcoStruxure Machine Expert - Basic toolbar
O or ALT+O		Other Ladder items	Ladder rung	EcoStruxure Machine Expert - Basic toolbar
A or ALT+A		Activate step	Ladder rung	EcoStruxure Machine Expert - Basic toolbar
D or ALT+D		Deactivate step	Ladder rung	EcoStruxure Machine Expert - Basic toolbar



!

%S

According to the IEC standard, %S represents a system bit.

%SW

According to the IEC standard, %SW represents a system word.

A

animation table

A software table that displays the real-time values of objects such as input bits and memory words. When EcoStruxure Machine Expert - Basic is connected to a logic controller, the values of certain object types in animation tables can be forced to specific values. Animation tables are saved as part of EcoStruxure Machine Expert - Basic applications.

application

A program including configuration data, symbols, and documentation.

C

configuration

The arrangement and interconnection of hardware components within a system and the hardware and software parameters that determine the operating characteristics of the system.

F

flash memory

A non-volatile memory that can be overwritten. It is stored on a special EEPROM that can be erased and reprogrammed.

Free POU

A programmable object unit (POU), typically containing library functions, that can be programmed and updated independently of the master task of a program. Free POUs are available to be called from within programs as subroutines or jumps. For example, the *periodic task* is a subroutine that is implemented as a Free POU.

G

GRAFCET

The functioning of a sequential operation in a structured and graphic form.

This is an analytical method that divides any sequential control system into a series of steps, with which actions, transitions, and conditions are associated.

I

instruction list language

A program written in the instruction list language that is composed of a series of text-based instructions executed sequentially by the controller. Each instruction includes a line number, an instruction code, and an operand (see IEC 61131-3).

L

ladder diagram language

A graphical representation of the instructions of a controller program with symbols for contacts, coils, and blocks in a series of rungs executed sequentially by a controller (see IEC 61131-3).

M

master task

A processor task that is run through its programming software. The master task has 2 sections:

- **IN:** Inputs are copied to the IN section before execution of the master task.
- **OUT:** Outputs are copied to the OUT section after execution of the master task.

N

non-program data

Data in a EcoStruxure Machine Expert - Basic application that is not directly used by the program, such as project properties, symbols, and comments.

P

post configuration

(post configuration) An option that allows to modify some parameters of the application without changing the application. Post configuration parameters are defined in a file that is stored in the controller. They are overloading the configuration parameters of the application.

POU

(*program organization unit*) A variable declaration in source code and a corresponding instruction set. POU's facilitate the modular re-use of software programs, functions, and function blocks. Once declared, POU's are available to one another.

R**RTC**

(*real-time clock*) A battery-backed time-of-day and calendar clock that operates continuously, even when the controller is not powered for the life of the battery.

S**symbol**

A string of a maximum of 32 alphanumeric characters, of which the first character is alphabetic. It allows you to personalize a controller object to facilitate the maintainability of the application.

symbolic addressing

The indirect method of addressing memory objects, including physical inputs and outputs, used in programming instructions as operands and parameters by first defining symbols for them using these symbols in association with the programming instructions.

In contrast to immediate addressing, this is the preferred method because if the program configuration changes, symbols are automatically updated with their new immediate address associations. By contrast, any immediate addresses used as operands or parameters are not updated (refer to *immediate addressing*).

T**TCP**

(*transmission control protocol*) A connection-based transport layer protocol that provides a simultaneous bi-directional transmission of data. TCP is part of the TCP/IP protocol suite.

U**user defined function**

It allows you to create your own functions with one or more input parameters, local variables, and a return value. The user-defined function can then be called in operation blocks. A user-defined function is stored as part of the project and downloaded to the logic controller as part of the application.

user defined function block

It allows you to create your own function blocks with one or more input and outputs, parameters, and local variables. User-defined function blocks are stored as part of the project.

W

watchdog

A watchdog is a special timer used to ensure that programs do not overrun their allocated scan time. The watchdog timer is usually set to a higher value than the scan time and reset to 0 at the end of each scan cycle. If the watchdog timer reaches the preset value, for example, because the program is caught in an endless loop, an error is declared and the program stopped.



A

- accumulator, *194*
- action zone, *170*
- addressing
 - symbolic, *68*
- allocating memory in controller, *70*
- allocation mode, *70*
- animation tables, *139*
- application
 - behavior, configuring, *77*
 - definition of, *28*
 - downloading to controller, *249*
 - protecting with a password, *55*
 - protecting with password, *58*
 - uploading from logic controller, *251*
 - whether password-protected, *260*
- assignment instructions
 - inserting in Ladder Diagram rungs, *182*

B

- backup memory contents, *236*
- bill of material (BOM), printing, *51*
- Boolean
 - accumulator, *194*
- Boolean operators
 - graphic elements for, *176*
- branching modes
 - graphic element, *175*
- buttons, toolbar, *45*

C

- cache memory, consumption of, *165*
- catalog, *61*
 - replacing logic controller with reference from, *62*
- coils
 - graphic elements for, *177*
 - graphical representation of outputs, *168*

- comments
 - adding to Instruction List, *192*
 - adding to Ladder Diagrams, *186*
- commissioning, *30*
 - Commissioning window, *240*
 - connecting to a logic controller, *242*
- communication objects, *156*
- comparison block
 - graphic elements for, *176*
- comparison blocks
 - inserting IL expressions in, *181*
- comparison expression
 - inserting in Ladder Diagram rungs, *181*
- compile, date and time of last, *165*
- configuration
 - current, *61*
 - replacing logic controller in, *62*
- configuring
 - application behavior, *77*
 - hardware components with Configuration window, *61*
 - master task, *116*
 - periodic task duration, *128*
 - project properties, *55*
 - tasks and scan, *82*
- connecting to a logic controller, *242*
- contacts
 - graphic elements for, *175*
 - graphical representation of inputs, *168*
- controller time, displaying in trace, *226*
- converting Twido projects to EcoStruxure Machine Expert - Basic, *283*
- copying and pasting
 - Grafcet POU, *93*
 - POU, *96*
- creating
 - Free POU, *95*
 - Grafcet POU, *93*
- creating projects, *28*
- customizing, Ladder Editor, *49*

D

- debugging in online mode, *225*
- developing programs, stages of, *29*
- development stages, *30*
- digital inputs
 - configuring as event sources, *131*
- downloading
 - firmware updates, *253*
 - user application to controller, *249*
- downloading non-program data, *236*
- Drive objects, *155*

E

- end/jump
 - graphic elements, *178*
- Ethernet
 - configuration using post configuration file, *260*
- event source
 - assigning subroutine as, *134*
 - types of, *131*
- event tasks
 - managing, *133*
 - configuring, *82*
 - overview, *130*
- events
 - since last cold restart, *135*
 - triggering subroutines with, *131*
- EXCEPTION state
 - fallback behavior, *79*
- expansion modules
 - supported devices, *24*
- exporting
 - symbol list, *162*
 - trace, *228*

F

- fallback
 - behavior, specifying, *79*
 - values, *79*
- firmware updates, *253*
- firmware, downloading updates to controller, *253*

- forcing values
 - in animation tables, *139*
 - of I/Os, *260*
- Free POU
 - assigning to an event source, *134*
 - assigning to events, *98*
 - assigning to periodic task, *98*
- Free POU
 - creating, *95*
- Free POU
 - for periodic task, *126*
 - introduction to, *86*
- Free POUs
 - removing, *97*
- function blocks
 - graphic element, *177*
- functional levels, *80*

G

- general settings, *49*
- Grafcet, *203*
 - graphical elements, *178*
 - how to use the instructions, *208*
 - instructions, *203*
 - post-processing, *207*
 - preprocessing, *204*
 - program structure, *204*
 - sequential processing, *206*
- Grafcet (SFC)
 - Grafcet Graphical Editor, *214*
- Grafcet POU
 - copying and pasting, *93*
 - creating, *93*
 - removing, *94*
 - renaming, *94*
- graphic elements
 - Ladder diagrams, *174*
- grid lines, style of in Ladder Editor, *49*

H

- hardware components, configuring, *61*
- hardware tree, *61*

help
changing shortcuts, *49*

I

importing
symbol list, *161*
input/output objects, *151*
inputs
configuring as event sources, *131*
modifying, *187*
inserting
new Grafset POU's, *93*
Instruction List
comments, *192*
instructions
upstream/downstream, *187*

K

keyboard shortcuts, *49, 293*

L

Ladder diagrams
comments, *186*
graphic elements, *174*
introduction, *168*
programming principles, *170*
reversing to Instruction List, *71*
rungs, *169*
using parentheses in, *188*
Ladder Editor
customizing, *49*
defining symbols in, *69*
resetting pointer after insertion, *49*
Ladder/List reversibility, *71*
language,
user interface, *49*
life cycle state
of logic controller, *47*
line
graphic element, *175*
List instructions, *195*

List language
overview, *191*
logic controller
date and time last stopped, *260*
displaying information about, *260*
displaying state, *260*
replacing current in configuration, *62*
state on startup, configuring, *77*
supported types, *24*
updating firmware, *253*
updating RTC of, *262*

M

maintaining fallback values, *79*
master task
assigning POU as, *86*
configuring, *82, 116*
system bits and words controlling, *117*
memory allocation, *70*
memory consumption, viewing, *165*
memory management with SD card, *254*
memory objects, *145*
minimum system requirements, *23*
modem
displaying status of, *260*
modes, operating, *31*
module areas, *30*

N

network objects, *152, 152*
new Grafset POU
inserting, *93*
non-program data, *28, 139*
downloading, *236*
normal scan mode, *117*

O

objects
definition of, *67*
network, *152*
to trace in animation table, *139*
updating values of in real time, *139*

- offline mode
 - displayed in status area, *47*
 - overview, *31*
- online mode, *70*
 - animation tables in, *139*
 - debugging, *225*
 - displayed in status area, *47*
 - editing values in animation table, *141*
 - overview, *31*
 - updating RTC in, *262*
- operands, *194*
- operating modes, *31*
- operation blocks
 - graphic element, *178*
 - inserting assignment instructions in, *182*
- operations
 - inserting in Ladder Diagram rungs, *182*
- outputs
 - modifying, *187*

P

- parentheses
 - modifiers, *200*
 - nesting, *200*
 - using in Ladder diagrams, *188*
 - using in programs, *199*
- password
 - protecting an application , *58*
 - removing from application, *58*
 - removing from project, *57*
 - requiring to open project file, *57*
 - whether application is protected with, *260*
- password-protecting an application, *55*
- period, scan, *117*
- periodic
 - scan mode, *117*
 - scan period, *128*
 - tasks, *126*
- periodic task
 - assigning Free POU to, *98*
 - configuring, *82*
 - configuring duration of, *128*

- post configuration
 - using Ethernet parameters from, *260*
 - using serial line parameters from, *260*
- POU
 - copying, *96*
 - Free, *126*
 - managing with tasks, *87*
 - overview, *86*
 - pasting, *96*
- printing reports, *51*
- priority level, of events, *130*
- program
 - compiling, *45*
 - definition of, *28*
 - displaying number of lines in, *165*
 - jumps, *187*
- program development, stages of, *29*
- program organization unit (POU), *86*
- program, configuring fallback behaviors, *79*
- programming
 - best practices, *187*
 - grid, *170*
 - languages, supported, *26*
 - workspace, *64*
- project
 - configuring properties, *55*
 - definition of, *28*
 - displaying report for, *51*
 - protecting with password, *57*
 - saving, *278*
 - saving as a template, *279*
 - templates, *38*
- projects
 - creating, *28*
- properties, *55*
- PTO objects, *154*
- pulse width (TON) , *117*

R

- RAM memory
 - executable contains application, *260*
- RAM memory, consumption of, *165*
- registering EcoStruxure Machine Expert - Basic software, *34*

- relay circuits, representing as Ladder diagrams, *168*
 - removing
 - Free POU, *97*
 - Grafcet POU, *94*
 - removing password protection, *57, 58*
 - renaming
 - a Grafcet POU, *94*
 - replacing
 - logic controller in configuration, *62*
 - reports
 - exporting, *51*
 - printing, *51*
 - reversibility
 - introduction to, *71*
 - rollback changes, *236*
 - RTC
 - displaying date and time, *260*
 - managing with system bits, *187*
 - updating in controller, *262*
 - rungs
 - copying, *91*
 - creating, *90*
 - deleting, *92*
 - graphic element, *174*
 - inserting, *90*
 - managing, *90*
 - renaming, *92*
- S**
- scan modes, *82, 117*
 - scan task, configuring watchdog, *79*
 - scan time
 - displaying minimum, maximum, current, *260*
 - minimum, displayed in status area, *47*
 - SD card
 - memory management with, *254*
 - search and replace, *157*
 - sections
 - in events, *130*
 - of master task, *116*
 - selection
 - graphic element, *175*
 - sending program modifications, *236*
 - serial line
 - configuration using post configuration file, *260*
 - settings
 - general, *49*
 - sharing
 - symbol list, *163*
 - sharing symbols
 - with Vijeo Designer project, *163*
 - simulator, *264*
 - accessing the simulator, *264*
 - how to use, *275*
 - I/O manager window, *266*
 - mode, overview, *31*
 - modifying values, *271*
 - modifying values of analog inputs, *272*
 - modifying values of digital inputs, *271*
 - output tracing, *273*
 - simulator windows, *264*
 - Time Management window, *268*
 - software objects, *153*
 - sources of events, *131*
 - stages of developing a program, *30*
 - startup state of logic controller, *77*
 - state
 - initial logic controller, configuring, *77*
 - of controller, displaying, *260*
 - status area, *47*
 - stop sensors, wiring, *187*
 - STOPPED state
 - fallback behavior, *79*
 - subroutine
 - assigning to periodic task, *126*
 - assigning to tasks, *133*
 - implementing as Free POU, *86*
 - of master task, *116*
 - triggering execution with an event, *131*
 - supported devices, *24*
 - symbol list
 - displaying, *160*
 - exporting, *162*
 - importing, *161*
 - sharing with Vijeo Designer project, *163*
 - symbolic addressing, *68*

symbols

- addressing with, *68*
- defining in graphic elements of ladder editor, *69*
- defining in Properties window, *68*
- list of used, *160*
- storing in logic controller, *69*

system bits

- %S0, *187*
- %S11, *117*
- %S14, *260*
- %S19, *117*
- %S31, *135*
- %S38, *135*
- %S39, *135*
- %S49, *187*
- %S51, *187*

system bits/words

- controlling events with, *135*
- in symbol list, *160*

system objects, *150*system requirements, *23*

system words

- %SW0, *117*
- %SW27, *117*
- %SW30, *117*
- %SW30...%SW32, *260*
- %SW31, *117*
- %SW32, *117*
- %SW35...%SW38, *260*
- %SW48, *135*
- %SW54...%SW57, *260*
- %SW58, *260*
- %SW6, *260*

T

task

- event, *130*
- periodic, *126*

tasks

- configuring, *82*

template

- project, *38*
- saving project file as, *279*

test zone, *170*

TH0, TH1

- configuring as event sources, *131*

threshold outputs (of %HSC)

- configuring as event sources, *131*

time base (for trace), *144*timer, watchdog, *79*toolbar buttons, *45*

tools

- animation tables, *139*
- communication objects, *156*
- Drive objects, *155*
- input/output objects, *151*
- memory consumption, *165*
- memory objects, *145*
- network objects, *152*
- PTO objects, *154*
- search and replace, *157*
- software objects, *153*
- symbols lists, *160*
- system objects, *150*
- using, *136*

trace

- displaying, *226*
- exporting to PDF, *228*
- selecting objects to, *139*
- selecting time base for, *144*

Twido projects, converting to EcoStruxure Machine Expert - Basic, *283*

U

uploading

- application from logic controller, *251*
- preventing with a password, *58*

user interface

- setting language, *49*

user-defined function

- managing, *105*
- programming, *101*

user-defined function block

- defining, *109*
- managing, *113*
- programming, *110*

W

watchdog timer, configuring, *79*

wiring stop sensors, *187*

X

XOR

graphic elements for, *176*

